

IMPORTANT: Read before using



Operating/Safety Instructions

Spindle HF350 / HF500



Call for consumer information

Customers from outside the U.S.

STPCRAFT GmbH & Co. KG
An der Beile 2
58708 Menden
Germany
Phone: 0049-2373-179 11 60
E-mail: info@stepcraft-systems.com

Customers from the U.S. / Canada

STPCRAFT Inc.
59 Field Street, Rear Building
Torrington, CT, 06790
United States
Phone: 001-203-5561856
E-mail: info@stepcraft.us

Original Operating/Safety
Instructions

Date of: 22-08-2017

NOTICE

All instructions, warranties and other collateral documents are subject to change at the sole discretion of STEPCRAFT, Inc. For up-to date product literature, visit www.stepcraft-systems.com for customers from Europe or www.stepcraft.us, for customers from US / Canada and click on the service & support tab for this product.

Meaning of Special Language

The following terms are used throughout the product literature to indicate various levels of potential harm when operating this product: The purpose of safety symbols is to attract your attention to possible dangers. The safety symbols, and their explanations, deserve your careful attention and understanding. The safety warnings themselves do not eliminate any danger. The instructions or warnings they give are not substitutes for proper accident prevention measures.

- NOTICE** Procedures, which if not properly followed, create a possibility of physical property damage AND little or no possibility of injury.
- CAUTION** Procedures, which if not properly followed, create a probability of physical property damage AND a possibility of serious injury.
- WARNING** Procedures, which if not properly followed, create a probability of property damage, collateral damage, serious injury or death OR create a high probability of superficial injury.



Safety Alert: Indicates caution or warning. Attention is required in order to avoid serious personal injury.



Read the ENTIRE instruction manual in order to become familiar with the features of the product and how to operate them. Failure to operate the product correctly can result in damage to the product, personal property and cause serious injury, electric shock and/or fire.

This is a sophisticated hobby and a semi-professional product for advanced craftsmen with previous experience in the operation of tools such as electric drills, routers and computerized tools like CNC routers or 3D printers. It must be operated with caution and common sense and requires some basic mechanical ability. Failure to operate this product in a safe and responsible manner could result in personal injury or damage to the product or other property. This product is not intended for use by children without direct adult supervision. Do not attempt disassembly, use with incompatible components or augment product in any way without the approval of STEPCRAFT GmbH & Co. KG or STEPCRAFT, Inc. This manual contains instructions for safety, operation and maintenance. It is essential to read and follow all the instructions and warnings in the manual, prior to assembly, setup or use, in order to operate correctly and avoid damage or serious injury.

Age Recommendation: For advanced handcrafters ages 14 and above. This is not a toy.

SAVE ALL WARNINGS AND INSTRUCTIONS FOR FUTURE REFERENCE.

Should you encounter any doubts or require any further information, please do not hesitate to contact us before commissioning of the power tool. Our contact details can be found on the front page of this manual.

The term “power tool” in the warnings refers to your mains-operated (corded) power supply and the spindle itself, hereafter referred to as STEPCRAFT high frequency spindle or “HFS”.

General Power Tool Safety Warnings

Work area safety

	Keep work area clean and well lit. Cluttered or dark areas invite accidents.
CAUTION	Do not operate power tools in explosive atmospheres, such as in the presence of flammable liquids, gases or dust. Power tools create sparks which may ignite the dust or fumes.
NOTICE	Keep children and bystanders away while operating a power tool. Distractions can cause you to lose control and can result in accidents.

Continued on next page

Electrical safety

⚠ WARNING	<p>Power tool plugs must match the outlet. Never modify the plug in any way. Do not use any adapter plugs with earthed (grounded) power tools. Unmodified plugs and matching outlets will reduce the risk of electric shock.</p> <p>Avoid body contact with earthed or grounded surfaces such as pipes, radiators, ranges and refrigerators. There is an increased risk of electric shock if your body is earthed or grounded.</p> <p>Do not expose power tools to rain or wet conditions. The spindle is only suitable for indoor use. Water entering a power tool will increase the risk of electric shock.</p> <p>Do not abuse the cord. Never use the cord for carrying, pulling or unplugging the power tool. Keep cord away from heat, oil, sharp edges or moving parts. Damaged or entangled cords increase the risk of electric shock.</p> <p>If operating a power tool in a damp location is unavoidable, use a Ground Fault Circuit Interrupter (GFCI). The use of a GFCI reduces the risk of electric shock.</p>
------------------	--

Personal safety

⚠ CAUTION	<p>Stay alert, watch what you are doing and use common sense when operating a power tool. Do not use a power tool while you are tired and/or under the influence of drugs, alcohol or medication. A moment of inattention while operating power tools may result in serious personal injury.</p>
NOTICE	<p>All persons who operate the power tool must have read and fully understood all relevant operating instructions. Misunderstanding may result in personal injury.</p>
⚠ CAUTION	<p>Use personal protective equipment. Always wear eye protection. Protective equipment such as a dust mask or hearing protection used for appropriate conditions will reduce personal injuries.</p>
	<p>Prevent unintentional starting. Ensure the switch is in the off-position before connecting the power tool to the power source, picking it up or carrying the tool. Carrying power tools with your finger on the switch or energizing power tools that have the switch on invites accidents.</p>
NOTICE	<p>Remove any adjusting key or wrench before turning the power tool on. A wrench or a key left attached to a rotating part of the power tool may result in personal injury.</p>
	<p>Do not overreach. Keep proper footing and balance at all times. This enables better control of the power tool in unexpected situations.</p>
NOTICE	<p>Dress properly. Do not wear loose clothing or jewelry. Keep your hair, clothing and gloves away from moving parts. Loose clothes, jewelry or long hair can be caught in moving parts.</p>
⚠ CAUTION	<p>If devices are provided for the connection of dust extraction and collection facilities, ensure these are connected and properly used. Use of dust collection can reduce dust-related hazards.</p>

Power tool use and care

	<p>Do not force the power tool. Use the correct power tool for your application. The correct power tool will do the job better and safer at the dedicated rate for which it was designed.</p>
NOTICE	<p>Do not use the power tool if the switch cannot be turned on and/or off. Any power tool that cannot be controlled with the switch is dangerous and must be repaired.</p>
⚠ CAUTION	<p>Disconnect the plug from the power source and/or the battery pack from the power tool before making any adjustments, changing accessories, or storing power tools. Such preventive safety measures reduce the risk of starting the power tool accidentally.</p>
⚠ CAUTION	<p>Store idle power tools out of the reach of children and do not allow persons unfamiliar with the power tool or these instructions to operate the power tool. Power tools are dangerous in the hands of untrained users.</p>
NOTICE	<p>Maintain power tools. Check for misalignment or binding of moving parts, breakage of parts and any other conditions that may affect the power tool's operation. If damaged, have the power tool repaired before use. Many accidents are caused by poorly maintained power tools.</p>
	<p>Keep cutting tools sharp and clean. Properly maintained cutting tools with sharp cutting edges are less likely to bind and are easier to control by the machine.</p>
	<p>Use the power tool, accessories and end mills etc. in accordance with these instructions, taking into account the working conditions and the work to be performed. Use of the power tool for operations different from those intended could result in a hazardous situation.</p>

Continued on next page

Service

	Have your power tool serviced by a qualified repair person using only identical replacement parts. This will ensure that the safety of the power tool is maintained.
--	---

Safety Rules for Rotary Tools

⚠ WARNING	Make sure that the power tool cannot cut its own cord, therefore never install the power cord across the machine table. Cutting a "live" wire may shock the operator.
	Use clamps or another practical and secure way to support the workpiece and secure it to the machine table. Holding the work piece with your hands leaves it unstable and may lead to loss of control.
NOTICE	Accessories must be rated for at least the speed recommended on the tool warning label. Accessories running over rated speed can fly apart and cause injury.
⚠ CAUTION	Always disconnect the power cord from the power source before making any adjustments or attaching any accessories. You may unexpectedly cause the tool to start leading to serious personal injury.
	Be aware of the switch location, when placing the tool down or when picking the tool up. You may accidentally activate the switch.
	Do not hold the spindle in your hands during the start-up. The reaction torque of the motor, as it accelerates to full speed, can cause the shaft to twist.
NOTICE	Always wear safety goggles and dust mask. Use only in well ventilated area. Using personal safety devices and working in safe environment reduces risk of injury.
	After changing the bits or making any adjustments, make sure the ER collet and the clamping nut are both securely tightened. Loose adjustment devices can unexpectedly shift, causing loss of control. Loose rotating components will be violently thrown.
⚠ CAUTION	This is not a handheld tool. The spindle is designed to be system-guided and must be operated in a CNC router or a Desktop CNC System. Operation of the power tool handheld may result in serious personal injury.
NOTICE	Do not reach in the area of the spinning bit. The proximity of the spinning bit to your hand may not always be obvious.
NOTICE	Do not operate wire and bristle brushes with the spindle. Bristles or wires will be discharged from the brush at high speeds, can fly apart and cause injury.
	Never use dull or damaged bits. Sharp bits must be handled with care. Damaged bits can snap during use. Dull bits require more force to push the tool, possibly causing the bit to break.
⚠ CAUTION	Use clamps to support the workpiece. Never hold a workpiece with your hands.
	Inspect your workpiece before cutting. For example, if carving wood, make sure there are no nails or foreign objects in the workpiece. Nails or foreign objects can cause the bit to break.
	The speed and feed of the bit when carving, routing or cutting is very important. Always observe the speed and feed for the particular bit recommended.
⚠ CAUTION	If the workpiece or bit becomes jammed or bogged down, turn the power tool "OFF" by the switch. Wait for all moving parts to stop and unplug the tool, then work to free the jammed material. If the switch to the tool is left "ON" the tool could restart unexpectedly causing serious personal injury.
NOTICE	Do not leave a running tool unattended, turn power off. Only when tool comes to a complete stop and is disconnected from the mains is it safe.
⚠ CAUTION	Do not touch the bit or collet after use. After usage bit and collet are too hot to be touched with bare hands.
	Clean the tool's air vents every 4 hours by using compressed air. Excessive accumulation of powdered metal inside the motor housing may cause electrical failures.
NOTICE	Do not allow familiarity gained from frequent use of your rotary tool to become commonplace. Always remember that a careless fraction of a second is sufficient to inflict severe injury.
⚠ CAUTION	Do not alter or misuse tool. Any alteration or modification is a misuse and may result in serious personal injury.
⚠ CAUTION	This product is not intended for use as a dental drill, in human or veterinary medical applications. Serious personal injury may result.
⚠ CAUTION	When using the end mills, V-bits or cutters, always have the work piece securely clamped. Never attempt to hold the work piece with your hands while using any of these accessories. The reason is that these tools will grab if they become slightly canted in the groove, and can kickback causing loss of control resulting in serious injury.

Continued on next page

Safety Rules for System-guided Tools











⚠ CAUTION	The spindle can be controlled by a control software of a CNC router. Therefore the power supply of the spindle has to be properly connected to the external output of the main board of the CNC router via a 15-pin Sub-D cable. Prior to each commissioning of the power tool the ON/OFF, speed and emergency button functionality has to be checked. Malfunction may result in serious personal injury.
NOTICE	Do not leave a running CNC System and power tool unattended, turn power off. Only when a CNC router or power tool come to a complete stop and are disconnected from the mains are they safe.

Additional Safety Warnings

	Depending on the application field of the machine (private or commercial), observe the applicable occupational safety and health, safety and accident prevention and environmental regulations, too.
NOTICE	GFCI and personal protection devices like electrician's rubber gloves and footwear will further enhance your personal safety.
⚠ CAUTION	Do not use AC only rated tools with a DC power supply. While the tool may appear to work, the electrical components of the AC rated tool are likely to fail and create a hazard to the operator.
⚠ CAUTION	Use clamps or another practical way to secure and support the workpiece to the machine table. Holding the workpiece with your hands leaves it unstable and may lead to loss of control.
	Develop a periodic maintenance schedule for your tool. When cleaning a tool be careful not to disassemble any portion of the tool since internal wires may be misplaced or pinched or safety guard return springs may be improperly mounted. Certain cleaning agents such as gasoline, carbon tetrachloride, ammonia, etc. may damage the surface.
⚠ CAUTION	Risk of injury to user. The power cord must only be served by a STEPCRAFT service facility.
⚠ WARNING	Some dust created by power cutting, routing, milling, drilling, and other construction activities contains chemicals known to cause cancer, birth defects or other reproductive harm. Some examples of these chemicals are: Lead from nonferrous metals with lead content, carbonate from carbon fiber, arsenic and chromium from chemically-treated lumber. Your risk from exposures to these varies, depending on how often you do this type of work. To reduce your exposure to these chemicals: work in a well ventilated area, and work with approved safety equipment, such as those dust masks that are specially designed to filter out microscopic particles.

Symbols

IMPORTANT: Some of the following symbols may be used on your tool. Please study them and learn their meaning. Proper interpretation of these symbols will allow you to operate the tool better and safer.

Symbol	Name	Designation / Explanation
V	Volts	Voltage (potential)
A	Amperes	Current
Hz	Hertz	Frequency (cycles per second)
W	Watt	Power
Kg	Kilograms	Weight
Min	Minutes	Time
S	Seconds	Time
mm	Length, Height, Width	Size in millimeter (metric)
inch	Length, Height, Width	Size in inch
∅	Diameter	Size of drill bits, end mills, etc.
.../min	Revolutions or reciprocation per minute	Revolutions, turns, etc. per minute
V→, V↓	Speed	Horizontal / vertical speed in millimeter per second
0	Display off position	Zero speed / revolution per minute
15, 45, 75, 99	Display selector settings	Speed / revolution per minute as percentage share of the max. speed / revolution. Higher number means greater speed. 99 equal the max. revolution per minute.
→	Arrow	Action in the direction of an arrow
	Warning symbol	Alerts user to warning messages
	CAUTION hot surface	Alerts user not to touch the surface – danger of burns
	CAUTION rotating tool	Alerts user not to touch the blade / the insertion tool - danger of lacerations
	Wear eye protection symbol	Alerts user to wear protective glasses
	Wear hand protection symbol	Alerts user to wear protective gloves
	Grounding symbol	Alerts user to ground the power tool / electrical system
	Wear ear protection symbol	Alerts user to wear a hearing protector
	Read manual symbol	Alerts user to read manual BEFORE first commissioning
	Unplug symbol	Alerts user to unplug the device BEFORE servicing the power tool
	Disposal symbol	Instructions for disposal of WEEE by users of the European Union

Content

1 GENERAL INSTRUCTIONS..... 9

1.1 Information and Explanations to the Operating Instructions.....9

1.2 Description of Components9

1.3 Intended Use.....9

2 Design and Function.....10

2.1 Designation of the Individual Parts of the Spindle.....10

2.2 Designation of the Controller Components10

3 Start-up11

3.1 Clamping the Spindle11

3.2 Environmental Requirements11

3.3 Electrical Connection of the Control unit.....11

3.4 Emergency Stop.....12

3.5 Optional Accessories.....12

3.5.1 Collets.....12

3.5.2 Insertion Tools.....12

4 Operator Control / Spindle13

4.1 Operator.....13

4.2 Control Unit.....13

4.3 Spindle.....14

4.4 Replacing the Collets15

4.5 Emergency-stop Switch.....15

4.5.1 Operation15

4.5.2 Testing the Spindle on / off and Emergency-stop Functionality16

4.6 Speed and Feed Settings.....16

5 Technical Specifications18

5.1 Dimensions and Weight of the Spindle18

5.2 Other Characteristics of the Spindle18

5.3 Pin Assignment of the Interface (15-pin D-sub Input Signals).....18

5.4 Spare Parts18

6 Transport / Storage18

6.1 Transport.....18

6.2 Packaging18

6.3 Storage19

7	Maintenance Information.....	19
7.1	Service.....	19
7.2	Cleaning.....	19
7.3	Extension Cords.....	19
8	Failure	20
8.1	Response to Malfunctions	20
9	Annex.....	20
9.1	Warranty and Service Contact information	20
9.2	Manufacturer	21
9.3	Type Plate.....	21
9.4	Copyright.....	21
9.5	Limited Warranty	21
9.6	Instructions for Disposal of WEEE by Users of the European Union.....	23
9.7	RoHS, 2002/95/EG	23
9.8	EC-Declaration of Conformity.....	24

1 GENERAL INSTRUCTIONS

1.1 INFORMATION AND EXPLANATIONS TO THE OPERATING INSTRUCTIONS

This manual is intended to familiarize you with your STEPCRAFT High Frequency Spindle (hereafter referred to as HFS) and its control system, providing you with all the necessary information you will need in order to operate it safely and professionally.

⚠ WARNING Please read this manual thoroughly and carefully prior to the first use of your STEPCRAFT HFS. Operate the machine and the associated control system only when you are sure that you have understood these instructions in their entirety. Hereby you minimize the risk of injury and / or prevent property damage.



Should you encounter any doubts or require any further information, do not hesitate to contact us. Our contact information can be found on the front page of this manual.

Keep this manual always in close proximity to the STEPCRAFT HFS for future reference.

We cannot be held accountable either for any kind of injury and / or property damage resulting from improper handling of the machine, deviating from the recommended use of the STEPCRAFT HFS or from failure to follow the safety regulations properly (see page 2 cont.).

We reserve the right to further develop the spindle as well as the control system.

1.2 DESCRIPTION OF COMPONENTS

The STEPCRAFT HFS consists of the milling spindle with the firmly attached cabling and a matching controller / frequency inverter. The spindle has a 43-mm collar as well as an active air cooling system. The milling cutters are mounted using ER11 collets. The lateral shaft lock button allows for a convenient tool change.

The ready-to-use unit consists of the following components:

1. Pre-built frequency converter in sheet steel housing
2. HF Spindle with a permanently attached cable and plug
3. Connection cable 15-pin Sub-D male-female
4. Operating instructions

For more information on optional accessories, see item 3.5 of this manual.

1.3 INTENDED USE

The STEPCRAFT HFS has been developed for private users (e. g. model designers) and for single or small batch production in the commercial sector. It is not suitable either for large-scale production or for integration into assembly lines. It is designed for the usage of cutters and engraving burins with a diameter up to 8 mm. The HFS is specifically designed for installation and connection to our STEPCRAFT machine series - Plug & Play.

2 DESIGN AND FUNCTION

⚠ WARNING Disconnect the plug from the power source before making any assembly, adjustment or change of accessories. Such preventive safety measures reduce the risk of starting the tool accidentally.



2.1 DESIGNATION OF THE INDIVIDUAL PARTS OF THE SPINDLE

- 1 = Cable lead
- 2 = Exhaust cover with air outlet openings
- 3 = Air intake openings
- 4 = Shaft lock button
- 5 = 43 mm Euro-neck intake
- 6 = ER11 collet nut

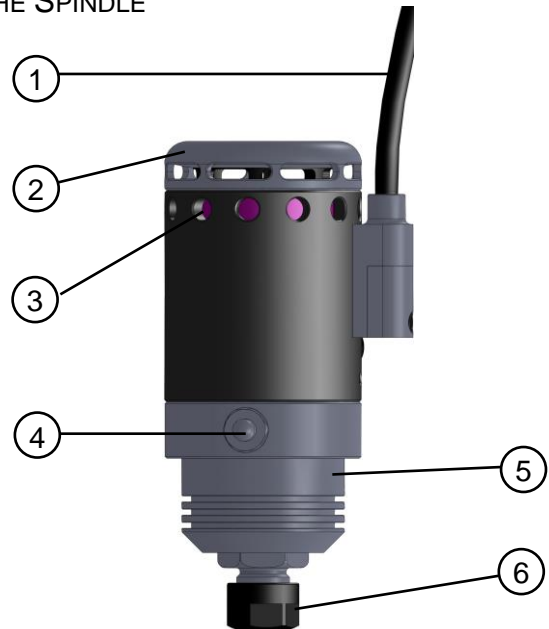

2.2 DESIGNATION OF THE CONTROLLER COMPONENTS

- 1 = Engine on / off LED
- 2 = Engine on / off switch
- 3 = Rotational speed "manual" setting
- 4 = Rotational speed display in %
- 5 = Main switch
- 6 = Signal input (STEEPCRAFT system bus)
- 7 = Spindle screw jack
- 8 = Power supply

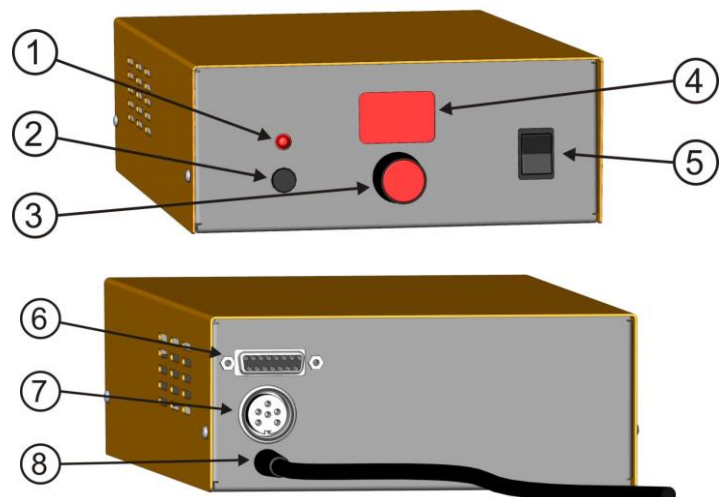

3 START-UP

⚠ WARNING Always unplug rotary tool before changing accessories, collets or servicing your rotary tool.



3.1 CLAMPING THE SPINDLE

The spindle is inserted, without any additional adapter, directly into the 43 mm Euro-tensioning system of the machine and is easily fixed. The shaft lock button (4) of the spindle should be facing forward. Thus, a simple tool change is possible.

The connecting cable and the hose of the spindle must run clean on the side, so that they cannot get caught in between the sideways of the machine.

3.2 ENVIRONMENTAL REQUIREMENTS

Attach the spindle to the 43 mm Euro-tensioning system of the STEPCRAFT machine or the adequate CNC router. Set the controller up in such a way that the cable feed cannot be crushed.

Make sure that there is sufficient room around the system so that you can work comfortably and the machine can fully extend its traversing paths. Maintain a sufficient safety distance from other machines.

The air surrounding the spindle is to be kept low-dust. An excessive exposure to dust may cause damage to the spindle.

Humidity should be within the usual levels for indoor environments. Protect the spindle against moisture and humidity. The ideal temperature of the system is between 18°C and 25°C.

Especially protect the electronics from overheating by avoiding exposure of the spindle and the controller to direct sunlight or close proximity to a heater.

Provide adequate lighting for the location of the machine and the work places surrounding it.

Position the PC controlling the machine in its near proximity in order to have both of them in clear view. All the instructions relevant to the machine and its components must be always kept nearby and within reach.

3.3 ELECTRICAL CONNECTION OF THE CONTROL UNIT

Connect the control unit to the system output of your STEPCRAFT Desktop CNC System using the supplied 15-pin Sub-D connection cable.

NOTICE: If you have a CNC router from a different brand check the external documentation to connect the spindle to the data output of the specific CNC router (see also item 5.3)

The control unit must be connected to the 110 V or 230 V mains respectively.

NOTICE: If the control unit is prepared with a NEMA 15-5 plug, 110 V are required (US model, see picture below). All other models have EU-specifications and require 220-240 V.



3.4 EMERGENCY STOP

The emergency-stop switch is located on the front of the machine (see figure in item 3.1 STEPCRAFT 3D Desktop Operating Instructions).

Pressing the switch triggers an emergency stop of the machine's operation. Simultaneously, the power supply to the control system is interrupted. In addition, the control software receives a signal to stop the operation. The machine will stop immediately.

⚠ CAUTION The emergency stop switch can only lead to a cessation of all components when they are properly connected to the emergency stop functionality of the mainboard.

⚠ WARNING If you are using third-party products, such as another control device, you are solely responsible for connecting the emergency stop functionality properly to the HFS controller. Otherwise a danger of personal injury or damage to property arises!

⚠ WARNING Even if you wish to use a system-held tool, such as a drilling and milling spindle, which has a separate on-off switch and is NOT controlled by the PC, you must ensure that these are connected correctly to the emergency-stop functionality of the mainboard. If you fail to do so, the tool will continue to run even when the emergency stop switch is being pressed. This poses a great danger to persons and property!

If you have any further questions, please do not hesitate to contact us!

For further information on the emergency-stop switch, refer to item 4.5 of this manual.

3.5 OPTIONAL ACCESSORIES

If you wish to use accessories not manufactured or sold by STEPCRAFT, make sure to check their compatibility with your system prior to its first application.

When in doubt, contact the manufacturer.

3.5.1 COLLETS

The spindle is not supplied with an ER11 collet. The following collets are available as options:

ER11 collet ø 1.0 mm	ER11 collet ø 5.0 mm
ER11 collet ø 2.0 mm	ER11 collet ø 6.0 mm
ER11 collet ø 2.5 mm	ER11 collet ø 7.0 mm
ER11 collet ø 3.0 mm	ER11 collet ø 8.0 mm
ER11 collet ø 3.175 mm (1/8")	ER11 collet nut M14x0.75 mm
ER11 collet ø 4.0 mm	

All collets are available separately in our online shop.

3.5.2 INSERTION TOOLS

Please note that the spindle and the machine can get overloaded quickly with the use of tools with large milling cutters. Therefore, use a customized step-over and an adaptable feed. Take into consideration that larger tools which are not finely balanced can lead to strong vibrations.

Different tools with various diameters (mostly between < 1.0 mm to 8.0 mm) are available. The shank sizes vary between 3.175 mm (1/8") and 4, 6 or 8 mm.

Type of tool	Technical specification	Applications
End mill 2-flute fish	<ul style="list-style-type: none"> - Solid carbide-end mill Ø1.0 mm - Double-flute - Fishtail bottom - Upcut- or downcut spiral 	<ul style="list-style-type: none"> - Universally applicable - Aluminum - Plastics - Wood
End mill diamond	<ul style="list-style-type: none"> - Solid carbide-end mill Ø1.0 mm - Diamond toothed - Fishtail 	<ul style="list-style-type: none"> - Glass fiber - Carbon fiber - Wood - Printed circuit boards
End mill single flute	<ul style="list-style-type: none"> - Solid carbide-end - Single-flute - Flat bottom - Upcut- or downcut spiral 	<ul style="list-style-type: none"> - High quality contours - Has only one flute, much space for chip evacuation - Very good for soft materials - Soft plastics - PE, teflon, plexiglas, styrofoam - Soft aluminum
End mill spiral	<ul style="list-style-type: none"> - Solid carbide-end mill Ø 2 mm - Spiral toothed - Fishtail - Upcut- or downcut spiral 	<ul style="list-style-type: none"> - Glass fiber - Carbon fiber - Wood - Printed circuit boards
Radius mill	<ul style="list-style-type: none"> - Solid carbide-radius mill - Center cut (diving possible) 	<ul style="list-style-type: none"> - Universal usability of all materials - Wood - Aluminum - Non-ferrous metals
V-bit	<ul style="list-style-type: none"> - Solid carbide V-router bit - tip angel from 30° to 120° - Single-cut with upcutting spiral 	<ul style="list-style-type: none"> - Engraving printed circuit boards - Engravings on many materials - Chamfering

4 OPERATOR CONTROL / SPINDLE

4.1 OPERATOR

The improper operation of the spindle and the control unit can cause serious injury and / or property damage.

Read and observe the major accident prevention regulations!

Each user must have read and understood the available instructions for the entire system (machine, system-held tool, control and software) before proceeding to operate the device for the first time.

4.2 CONTROL UNIT

After switching on the control unit, it connects to the spindle engine. Upon a successful connection, an audible confirmation can be heard (5 tones). The spindle is now ready for operation. The set point speed can be preselected at the speed dial (3). If you press the (2) button, the spindle begins to turn and rotates at the preset speed.

The speed may be adjusted during operation through the dial or between any of the settings.

Refer to the chart in item 4.6 to determine the proper speed and feed, based on the material being processed and the type of accessory being used. These charts enable you to choose both correct accessory and the optimum speed at a glance.

The speed of the HFS is manually controlled by adjusting this dial on the controller.

Settings for approximate revolutions

Switch setting	Speed range
20	20% of the maximum speed, approx. 4,000 RPM
40	40% of the maximum speed, approx. 8,000 RPM
60	60% of the maximum speed, approx. 12,000 RPM
80	80% of the maximum speed, approx. 16,000 RPM
99	99% of the maximum speed, approx. 20,000 RPM

The spindle can also be "remote controlled" with the 15-pin D-sub cable by means of the machine software and the program loaded. You can start and stop the HFS either via command line or the signal test of the control software. Please refer to the manual of the control software.

G-code command to start / stop the spindle

Command	Function
M03 S5000	Starts the spindle (clockwise) with a revolution of 5,000 RPM. The maximum value for the revolution can be S20000.
M05	Stops the spindle

4.3 SPINDLE

⚠ WARNING Never touch the tool! This poses a serious risk of injury!



To change a tool, block the spindle by pressing the shaft lock button (4). Using a 17 mm open-end wrench, the lock nut can now be released and screwed down (see picture below).

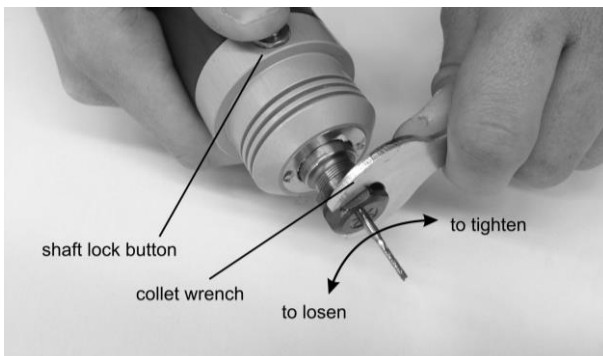

⚠ CAUTION Do not engage shaft lock while the rotary tool is running!

4.4 REPLACING THE COLLETS

The collets must snap into the clamping nut. Only then, a correct clamping of the end mill and, above all, a re-release of the collet are possible.

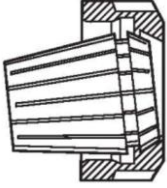
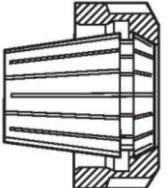
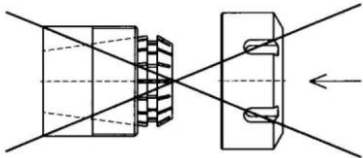
Change of ER collets	
<p>1.</p> 	<p>Move tongue of clamping nut diagonal into the ER collet until a click is being heard (pic. 1).</p>
<p>2.</p> 	<p>If the ER collet is in the correct position (pic. 2), cutters, end-mills, etc. can be inserted.</p>
<p>3.</p> 	<p>Pic. 3 shows the <u>wrong</u> insertion of the ER collet.</p>

4.5 EMERGENCY-STOP SWITCH

4.5.1 OPERATION

The emergency-stop switch is located on the front of the STEPCRAFT Desktop CNC System. Pressing the emergency button leads to an emergency stop of the machine and the HFS. The machine will stop immediately.

Actuate the emergency-stop switch only in emergency situations.

NOTICE: Actuating the emergency-stop will result in immediate machine shutdown and can cause step and data losses.

Controlled cessation of the machine's operation can only be effectuated via the control software.

To cancel the emergency stop status, turn the emergency-stop switch to the right. Then the control is re-enabled. The work process must be restarted.

The entire system is controlled and operated by the PC.

CAUTION Prior to first usage, read the manual of your control software thoroughly and carefully, making sure that you have understood everything.



For questions regarding the control software, please contact the respective software developer.

4.5.2 TESTING THE SPINDLE ON / OFF AND EMERGENCY-STOP FUNCTIONALITY

For testing the on / off and emergency-stop functionality with the control software of the machine, the spindle must be connected to the HFS controller. Additionally, the HFS controller has to be connected to the mainboard of the machine by using the Pin-15 D-sub cable.

NOTICE: For questions regarding the control software, please contact the respective software developer.

Manual test:

- Start the control software of the CNC router / STEPCRAFT Desktop 3D System.
- Mount the spindle on the tensioning system of the machine.
- Switch on the HFS controller, an audible confirmation can be heard. Do not start the spindle.
- Start the spindle with the signal test / I/O (if applicable) of the control software of the machine.
- Press the emergency button, the spindle should stop immediately.

Automatic operation:

For an automatic operation you need to prepare a file for the control software of the machine:

```
G21 ; set units to millimeters
G91 ; use relative coordinates
M3 S5000 ; spindle start
G1 F500.000 Y-40.00000 ; feed with 500 mm/min.
G1 F500.000 X-40.00000 ; feed with 500 mm/min.
G1 F500.000 Y40.00000 ; feed with 500 mm/min.
G1 F500.000 X40.00000 ; feed with 500 mm/min.
M5 ; spindle stop
M30 ; program end
```

Prepare the file with an ASCII-editor of your computer, for example notepad.exe, and save it as "test.nc" file.

- Start the control software of the CNC router / STEPCRAFT Desktop 3D System.
- Mount the spindle on the tensioning system of the machine.
- Switch on the HFS controller, an audible confirmation can be heard. Do not start the spindle.
- Start the homing sequence of the CNC router / STEPCRAFT Desktop 3D System.
- Load the "test.nc" file.
- Jog the gantry to the middle position of each axis (X, Y, Z) and save this position as zero position of the imaginary workpiece.
- Start the program, the spindle should start and the machine drives a square of 40 mm by 40 mm. After completing the square, the spindle stops and the program ends.
- Start the program again and press the emergency button during the program sequence, machine and spindle should stop immediately.

4.6 SPEED AND FEED SETTINGS

Many applications and accessories (insertion tools, for example an end mill cutter) will provide the best performance at full speed, but for certain materials, applications and accessories you need to proceed with slower speeds, which is the reason a variable speed control is available.

Certain materials (some plastics and precious material, for example) however, require a relatively slow speed and feed because, at high speed, the friction of the insertion tool generates heat and may cause damage to the material and the accessory.

Hardwoods and metals require high speed operation.

To aid you in determining the optimum operational speed and feed for different materials and accessories, we compiled a table. By referring to this table, you can discover the recommended speeds and feeds for each type of accessory / workpiece material. Examine this table properly and become familiar with it.

Ultimately, the best way to determine the correct speed and feed for work on any material, is to practice on a piece of scrap, even after referring to the chart. You can quickly learn that a slower or faster speed / feed is more effective, just by observing what happens during processing a pass or two at different speeds / feeds. When working with plastic, for example, start at a slow rate of speed / feed and increase the speed until you observe that the plastic is melting at the point of contact. Then reduce the speed slightly to get the optimum working speed. Secondly increase the feed until you observe that the accessory starts to chatter at the point of contact. Then reduce the feed or the infeed depth slightly to get the optimum working feed and infeed depth.

Some rules of thumb in regard to speed / feed / infeed depth:

1. Plastics and other materials that melt at low temperature should be cut at low speeds.
2. Wood should be cut at high speeds.
3. Hardwoods, carbon fiber and aluminum should be cut at high speeds. If the end mill starts to chatter, this normally means it is running too slow or the feed / infeed depth has to be reduced.
4. Aluminum, copper and brass may be cut at various speeds, depending on the type of cutting being done. Use suitable cutting oils on the end mill in order to prevent the cut material from adhering to the cutter teeth and to support the cutting process.
5. Check the material composition. Every material has its own characteristics and some materials are hard to cut, for example aluminum if it is not an alloy suitable for cutting / milling.

If the insertion tool is not performing as you think it should, perhaps you should be using a different accessory and probably an adjustment in speed / feed / machine setting, a play-free system is mandatory, would solve the problem.

MID = Maximum infeed depth per cycle [mm]

RPM = Revolution per minute of the HFS [1000x n/min.]

V→ = Horizontal feed speed (X-/Y-direction) [mm/s]

V↓ = Vertical speed (Z-direction) [mm/s]

Ø = Diameter of end mill [mm]

Material	Type of end mill	Ø 1				Ø 2				Ø 3			
		MID	RPM	V↓	V→	MID	RPM	V↓	V→	MID	RPM	V↓	V→
Softwood	End mill spiral	5	20	4	12	6	15	5	18	8	10	5	14
Hardwood	End mill spiral	2	18	3	4	3	12	4	6	4	8	4	5
Carbon fiber	End mill diamond or spiral	3	20	3	4	3	16	4	4	2	12	4	3
Glass-fiber reinforced plastic	End mill diamond or spiral	3	20	3	4	3	16	4	4	2	12	4	3
Soft plastic	End mill single flute	5	12	4	4	6	12	5	6	8	6	5	6
Hard plastic	End mill single flute	2	18	3	3	3	14	4	5	4	10	3	4
Acrylic glass	End mill 2-flute fish	2	15	1	3	3	12	2	5	3	8	2	4
Aluminum (alloy with plumb)	End mill 2-flute fish	0.5	20	1	2	1	17	1	2	1	14	1	2
Brass	End mill 2-flute fish	0.5	20	1	2	1	17	1	2	1	14	1	2

NOTICE: The table expresses a guideline only; the optimum working speed depends on machine size and play-free assembly, condition of spindle and insertion tool as well as on quality of workpiece material.

NOTICE: Engraving cutters (V-bit) should run at maximum speed with twice as much feed as mentioned in the table above. The maximum infeed depth should be 0.3 mm.

5 TECHNICAL SPECIFICATIONS

5.1 DIMENSIONS AND WEIGHT OF THE SPINDLE

- Length: 130 mm
- Diameter: 52 mm
- Weight: 0.65 kg
- Clamping neck: 43 mm (Euro neck)
- Cable length: approx. 2 m / 6 feet

5.2 OTHER CHARACTERISTICS OF THE SPINDLE

- Collet diameter: ER11, max. 8.0 mm
- Housing: Aluminum 7075 anodized,
- Type of the engine: Three-phase asynchronous engine
- Speed range: 3000-20000 rpm, clockwise rotation
- Electronic control: Governor electronic to provide maximum torque at all speeds
- Maximum voltage: 24 V
- Maximum current: 14.6 A / 20.8 A
- Maximum torque: 0.17 Nm / Nm 0.25
- Maximum cutting force (Ø 2mm): 163 N / 240 N
- Maximum performance: 350 W / 500 W
- Type and number of ball bearings: Steel, lubricated for life, 3x
- Run-out in the clamping taper in mm: <0.01
- Cooling: Labyrinth air cooling
- Additional features: Shaft lock button

5.3 PIN ASSIGNMENT OF THE INTERFACE (15-PIN D-SUB INPUT SIGNALS)

Pin number	Function	Pin number	Function
1	Not used	9	Not used
2	GND (mass)	10	GND (mass)
3	Not used	11	Not used
4	Not used	12	Not used
5	Not used	13	Spindle on / off
6	Not used	14	Not used
7	PWM Signal (0-5V)	15	Not used
8	Not used	---	---

5.4 SPARE PARTS

All parts of the spindle and the controller can be purchased separately.

Our contact details can be found on the front page of this manual.

6 TRANSPORT / STORAGE

6.1 TRANSPORT

Please make sure that the spindle is not exposed to heavy shocks during transport. This can lead to unwanted vibrations. If necessary, transport the device in suitable containers.

6.2 PACKAGING

If you do not want to re-use the packaging material of the spindle and the control unit, remove it properly and according to disposal conditions at the site and carry it to the recycling or disposal unit.

6.3 STORAGE

In case of prolonged downtime of the spindle and the control unit please observe the following storage conditions:

- Store the device and its components in an indoor environment.
- Protect from moisture, humidity, cold, heat and direct sunlight.
- Store in a dust-free environment, cover if necessary.
- The storage site should be free of any vibrations.

7 MAINTENANCE INFORMATION

7.1 SERVICE

To ensure continued enjoyment of your STEPCRAFT HFS, handle it carefully.

Regular maintenance positively affects the life expectancy of the device.

⚠ WARNING - Preventive maintenance performed by unauthorized personnel may result in misplacing of internal wires and components which could cause serious hazard. We recommend that all tool service be performed by a STEPCRAFT service facility.

⚠ WARNING - To avoid injury from unexpected starting or electrical shock, always remove plug from wall outlet before performing service or cleaning.



The HFS has ball bearing construction. Under normal use no additional lubrication is required.

7.2 CLEANING

⚠ WARNING - To avoid accidents always disconnect the rotary tool from the power supply before cleaning or performing any maintenance. The tool may be cleaned most effectively with compressed dry air. Always wear safety goggles when cleaning tools with compressed air.



Make sure to carry out the maintenance/care work every 4 working hours. Depending on the accumulation of dust and/or powdered metal inside, the engine's interior has to be cleaned by gently using of compressed air. Also clean the collet cone regularly with a fine cloth.

Ventilation openings and switch levers must be kept clean and free of foreign matter. Do not attempt to clean by inserting pointed objects through openings.

Also make sure that no coarse chips and as little dust as possible is entering the ventilation system.

⚠ CAUTION Certain cleaning agents and solvents damage plastic parts and/or the coating. Some of these are: gasoline, carbon tetrachloride, chlorinated cleaning solvents, ammonia and household detergents that contain ammonia.

⚠ CAUTION To continue using the tool in unmaintained condition will permanently damage your tool.

7.3 EXTENSION CORDS

If an extension cord is necessary, a cord with adequate size conductors that is capable of carrying the current necessary for your tool must be used.

This will prevent excessive voltage drop, loss of power or overheating. Grounded tools must use 3-wire extension cords that have 3-prong plugs and receptacles.

NOTICE: The smaller the gauge number, the heavier the cord.

**RECOMMENDED SIZES OF EXTENSION CORDS
120 VOLT ALTERNATING CURRENT CORD**

Tool's ampere rating	Cord size in A.W.G.				Wire sizes in mm ²			
	Cord length in feet				Cord length in meters			
	25	50	100	150	15	30	60	120
3-6	18	16	16	14	0.75	0.75	1.50	2.50
6-8	18	16	14	12	0.75	1.00	2.50	4.00
8-10	18	16	14	12	0.75	1.00	2.50	4.00
10-12	16	16	14	12	1.00	2.50	4.00	-
12-16	14	12	-	-	-	-	-	-

**RECOMMENDED SIZES OF EXTENSION CORDS
240 VOLT ALTERNATING CURRENT CORD**

Tool's ampere rating	Cord size in A.W.G.				Wire sizes in mm ²			
	Cord length in feet				Cord length in meters			
	25	50	100	150	15	30	60	120
1-3	18	16	16	14	0.75	0.75	1.50	2.50
3-4	18	16	14	12	0.75	1.00	2.50	4.00
4-5	18	16	14	12	0.75	1.00	2.50	4.00
5-6	16	16	14	12	1.00	2.50	4.00	-
6-8	14	12	-	-	-	-	-	-

8 FAILURE

8.1 RESPONSE TO MALFUNCTIONS

CAUTION If a failure occurs on the device that could cause personal injury or property damage, stop the operation immediately using the emergency-stop switch!

NOTICE: For less serious malfunctions, stop the machine / device normally using the controller. If you cannot fix the malfunction yourself, please contact us, specifying the fault which has occurred.

Our contact details can be found on the front page of this manual.

9 ANNEX

9.1 WARRANTY AND SERVICE CONTACT INFORMATION

Country of Purchase	STEEPCRAFT	Address	Phone no. / E-mail address
United States of America	STEEPCRAFT Inc.	733 E Main St. Unit 3 Torrington, CT, 06790	+1 203 556 1856 info@stepcraft.us
Germany	STEEPCRAFT GmbH & Co. KG	An der Beile 2 58708 Menden Germany	+49 2373 179 11 60 info@stepcraft-systems.com
Rest of the world	Local distributor STEEPCRAFT GmbH & Co. KG	see http://www.stepcraft-systems.com/en/company/reseller An der Beile 2 58708 Menden Germany	see http://www.stepcraft-systems.com/en/company/reseller +49 2373 179 11 60 info@stepcraft-systems.com

9.2 MANUFACTURER



STEPCRAFT GmbH & Co. KG
 An der Beile 2
 58708 Menden
 Germany

Phone: +49 (0) 2373 – 179 11 60
 E-mail: info@stepcraft-systems.com
 Website: www.stepcraft-systems.com

9.3 TYPE PLATE

The type plate can be found at the left side of the machine on the inspection flap.

Example:

HF Spindle Controller	
Typ: HFS-500 Watt, 110V 60Hz	
RPM: 20.000	 
Serial-Nr.: 103002	
Stepcraft GmbH & Co. KG An der Beile 2 - 58708 Menden - Germany	

9.4 COPYRIGHT

The contents of these operating instructions are the intellectual property of the STEPCRAFT GmbH & Co. KG. Forwarding or copying (also in excerpts) is not allowed without our explicit and written authorization. Any infringements are prosecuted.

9.5 LIMITED WARRANTY

What this warranty covers

STEPCRAFT GmbH & Co. KG (“STEPCRAFT”) warrants to the original purchaser that the product purchased (the “product”) will be free from defects in materials and workmanship at the date of purchase.

What is not being covered

This warranty is not transferable and does not cover (i) cosmetic damage, (ii) damage due to acts of God, accident, misuse, abuse, negligence, commercial or improper use, installation, operation or maintenance, (iii) modification of or to any part of the product, (iv) attempted service by anyone other than a STEPCRAFT authorized service center, (v) products not purchased from an authorized STEPCRAFT dealer, or (vi) products not compliant with applicable technical regulations.

OTHER THAN THE EXPRESS WARRANTY ABOVE, STEPCRAFT MAKES NO OTHER WARRANTY OR REPRESENTATION AND HEREBY DISCLAIMS ANY IMPLIED WARRANTIES, INCLUDING, WITHOUT LIMITATION, THE IMPLIED WARRANTIES OF NON-INFRINGEMENT, MERCHANTABILITY AND FITNESS FOR A PARTICULAR PURPOSE. THE PURCHASER ACKNOWLEDGES THAT HE ALONE HAS DETERMINED THAT THE PRODUCT WILL SUITABLY MEET THE REQUIREMENTS OF THE PURCHASER’S INTENDED USE.

Purchaser’s remedy

STEPCRAFT’s sole obligation and purchaser’s sole and exclusive remedy shall be that STEPCRAFT will, at its option, either (i) service, or (ii) replace any product determined by STEPCRAFT to be defective. STEPCRAFT reserves the right to inspect any and all product(s) involved in a warranty claim.

SERVICE OR REPLACEMENT AS PROVIDED UNDER THIS WARRANTY IS THE PURCHASER’S SOLE AND EXCLUSIVE REMEDY.

Limitation of liability

STEPCRAFT SHALL NOT BE LIABLE FOR SPECIAL, INCIDENTAL OR CONSEQUENTIAL DAMAGES, LOSS OF PROFITS OR PRODUCTION OR COMMERCIAL LOSS IN ANY WAY, REGARDLESS OF WHETHER SUCH CLAIM IS BASED IN CONTRACT, WARRANTY, TORT, NEGLIGENCE, STRICT LIABILITY OR ANY OTHER THEORY OF LIABILITY, EVEN IF STEP CRAFT HAS BEEN ADVISED OF THE POSSIBILITY OF SUCH DAMAGES. Further, in no event shall the liability of STEP CRAFT exceed the individual price of the product on which liability is asserted. As STEP CRAFT has no control over usage, setup, final assembly, modification or misuse, no liability shall be assumed or accepted for any resulting damage or injury. By the act of use, setup or assembly, the user accepts all resulting liability. If you as the purchaser or user are not prepared to accept the liability associated with the use of the product, the purchaser is advised to return the product immediately in new and unused condition to the place of purchase.

Law

These terms are governed by German law (without regard to conflict of law principals).

This warranty gives you specific legal rights additional to other rights you may have. STEP CRAFT reserves the right to change or modify this warranty at any time without notice.

Warranty services**Questions, assistance, and service**

Your local STEP CRAFT store and / or place of purchase cannot provide warranty support or service. Once assembly, setup or usage of the products has been started, you must contact your local distributor or STEP CRAFT directly. This will enable STEP CRAFT to better answer your question and help you in the event that you may need any assistance. For questions or assistance, please visit our website or call us in order to speak to a product support representative (see contact details 9.1).

Inspection or services

If this product needs to be inspected or serviced and is compliant in the country you live and use the product, please use the STEP CRAFT online service request submission process found on our website or call STEP CRAFT. Pack the product securely using a shipping carton. Please note that original boxes may be included but are not designed to withstand the rigors of shipping without additional protection. Ship via a carrier that provides tracking and insurance for lost or damaged parcels, as STEP CRAFT is not responsible for merchandise until it arrives and is accepted at our facility. When calling STEP CRAFT, you will be asked to provide your complete name, street address, e-mail address and phone number where you can be reached during business hours. When sending products to STEP CRAFT, please include your contact details and a list of the items included as well as a brief summary of the problem. A copy of your original sales receipt must be included for warranty consideration. Be sure your name and address are clearly written on the outside of the shipping carton.

Warranty requirements



For warranty consideration, you must include your original sales receipt verifying the proof-of-purchase date. Provide warranty conditions have been met, your product will be serviced or replaced free of charge. Service or replacement decisions are at the sole discretion of STEP CRAFT.

NON-warranty service

Should your service not be covered by warranty, service will be completed and payment will be required without notification or estimate of the expense unless the expense exceeds 50% of the retail purchase cost. By submitting the item for service you are agreeing to payment of the service without notification. Service estimates are available upon request. You must include this request with your items submitted for service. Non-warranty service estimates will be billed a minimum of ½ hour of labor. In addition you will be billed for return freight. STEP CRAFT accepts money orders, cashier's checks as well as credit cards and PayPal payment. By submitting any item to STEP CRAFT for service, you are agreeing to STEP CRAFT's Terms and Conditions found on our website (see contact details on front page).

ATTENTION: STEP CRAFT service is limited to product compliant in the country of use and ownership. If received, a non-compliant product will not be serviced. Further, the sender will be responsible for arranging return shipment of the unserviced product through a carrier of the sender's choice and at the sender's expense. STEP CRAFT will hold non-compliant product for a period of 60 days from notification after which it will be discarded.

9.6 INSTRUCTIONS FOR DISPOSAL OF WEEE BY USERS OF THE EUROPEAN UNION

 	<p>This product must not be disposed of with other waste. Instead, it is the user's responsibility to dispose of their waste equipment by handing it over to a designated collection point for the recycling of waste of electrical and electronic equipment. The separate collection and recycling of your waste equipment at the time of disposal will help to conserve natural resources and ensures that it is recycled in a manner that protects human health and the environment. For more information about where you can drop off your waste equipment for recycling, please contact your local office, your house-hold waste disposal or where you purchased your product.</p>
--	---

9.7 RoHS, 2002/95/EG

We confirm that the STEPCRAFT HF Spindle complies with the RoHS, 2002/95/EC.

9.8 EC-DECLARATION OF CONFORMITY



EC Manufacturer's Declaration of Conformity

in terms of the directive 2006/42/EC, appendix II part 1 A

Manufacturer: STEPCRAFT GmbH & Co. KG
 Address: An der Beile 2, 58708 Menden, Deutschland
 Type of product: STEPCRAFT Hochfrequenzspindel
 Type designation: HF350 / HF500

Hereby we declare that the device named above is consistent with the following relevant regulations:

- EU machine directive 2006/42/EC
- EC EMC directive 2004/108/EC
- The machine observes the protection targets of the EC low voltage directive (LVD) 2006/95/EC.

Applied harmonized standards, whose references have been published in the Official Journal of the European Communities:

EN 61029-1 11/2010 Sicherheit transportabler motorbetriebener Elektrowerkzeuge Teil 1: Allgemeine Anforderungen

Representative for the compilation of the technical documentation is the signatory of this declaration.

This declaration becomes void if not authorized modifications are made to the device.

Menden, den 22.08.2017

STEPCRAFT GmbH & Co. KG,
An der Beile 2, 58708 Menden

Markus Wedel
Kaufmännischer Geschäftsführer

Peter Urban
Technischer Geschäftsführer

Copyright ©

STEPCRAFT™