

***ATC71-ISO30  
INSTRUCTION  
MANUAL***

***Practical guide to the correct use of  
Automatic Tool Changer ISO30***

The documentation supplied with the electrospindle comprises the following documents :

- Instruction for the correct installation, use and maintenance of electrospindle.
- Attachments : Overall dimensions, electrical specifications, power-torque speed diagram
- Constructor's declaration

The Attachments are an integral part of the documentation and must be consulted in conjunction with this manual to avoid missing important information. Check that all above documents are present when the electrospindle is delivered. Ask Teknomotor S.r.l. for copies of any missing documents.

This manual has been written by Technical department – Teknomotor S.r.l., for use by all installers , operators and service technicians working with Teknomotor electrospindles.

Issued by	Code	Rev.	Approved by
Teknomotor S.r.l. Via Argenega,31 32038 Quero Vas (BL)			

List of updates:

Rev.	Added	Deleted	Changed

This manual is supplied together with the electrospindle. At its revision date, it was the most up to date documentation available on this product.



## SUMMARY

1. INTRODUCTION.....	7
1.1. PURPOSE OF THE MANUAL.....	7
1.2. GENERAL SAFETY SYMBOLS.....	7
2. WARNING AND SAEFTY PRECAUTIONS.....	8
2.1. RISKS ASSOCIATED WITH IMPROPER USE AND HANDLING.....	8
2.2. RISKS SPECIFIC TO ELECTROSPINDLE MAINTENANCE.....	9
3. GENERAL INFORMATION.....	9
3.1. PROPER USE OF ELECTROSPINDLE.....	9
3.2. RANGE OF APPLICATION.....	9
3.3. GENERAL CONDITION OF SALE.....	9
4. TECHNICAL SPECIFICATIONS.....	14
4.1. THE MAIN PARTS OF THE ELECTROSPINDLE.....	14
4.2. IDENTIFYNG THE MOTOR DATA FROM THE NAME PLATE.....	15
4.3. GENERAL VIEWS, OVERALL DIMENSIONS AND PERFORMANCE.....	15
5. TRASPORT, PACKAGING, UNPAKAGING AND STORAGE.....	16
5.1. PACKAGING AND LIFTING.....	16
5.2. STORAGE.....	16
6. INSTALLATION.....	17
6.1. CHECKING FOR DAMAGE.....	17
6.2. PROVISION OF ON SITE INSTALLATION EQUIPMENT.....	17
6.3. MECHANICAL CONNECTIONS.....	17
6.3.1. POSITIONING OF ELECTROSPINDLE.....	17
6.3.2. ELECTROSPINDLE RESTING SURFACE.....	17
6.3.3. TOOL CHANGE SYSTEM.....	17
6.3.4. FIXING ELECTROSPINDLE.....	18
6.4. PNEUMATIC CONNECTION.....	19
6.4.1. AIR PURITY.....	19
6.4.2. PNEUMATIC CONNECTION DIAGRAM.....	20
6.5. PNEUMATIC SPINDLE NOSE CLEANING.....	21
6.6. NOSE PRESSURISATION.....	21
6.7. ELECTRICAL CONNECTIONS.....	21
6.7.1. LAYOUT OF POWER CONNECTOR.....	21
6.7.2. LAYOUT OF SIGNAL CONNECTOR.....	22
6.8. ELECTRIC FAN.....	22
6.9. TOOL MANUAL RELEASE BUTTON.....	23

7. GENERAL CHECKS AFTER INSTALLATION IN THE MACHINE AND PRIOR START-UP .....	24
7.1. CHECKING ON THE ELECTROSPINDLE PRIOR TO START-UP .....	24
7.2. CHECKING ON THE ELECROSPINDLE AT THE TIME OF FIRST START-UP.....	25
7.3. CHECKING ON THE ELECTROSPINDLE BEFORE RUNNING IT.....	25
8. OPERATION OF THE ELECTROSPINDLE .....	26
8.1. CLIMATIC LIMITATIONS .....	26
8.2. FORECAST AND NON FORECAST USE .....	26
8.3. RUNNING IN.....	26
8.4. WARMING UP .....	27
8.5. TOOL-HOLDER LOCKING AND EXPULSION DEVICE.....	27
8.6. TOOL-HOLDER CONE .....	27
8.7. INSTALLATION OF THE PULL STUD ON THE ISO30 CONE.....	28
8.8. GENERAL RACCOMANDATION FOR THE TOOL HOLDER CONES .....	28
8.9. TOOL MOUNTING – TOOLHOLDER .....	28
8.10. TOOL MOUNTING – TOOLHOLDER WITH CONICAL SEAT FOR ER DIN 6499.....	29
8.11. MAXIMUM RUN-OUT AND VIBRATION VALUES .....	30
8.12. SPEED LIMITS .....	31
8.13. WHAT TO DO IF THE TOOL IS BLOKED ON THE PIECE BEING WORKED .....	31
8.14. SENSORS .....	31
8.14.1. TECHNICAL CHARACTERISTICS OF THE INDUCTIVE SENSORS.....	32
8.14.2. STATUS MODES OF THE ELECTROSPINDLE AND CORRESPONDING OUTPUTS .....	33
8.14.3. TRIMMING SENSORS .....	33
8.14.4. SENSOR S3 OUTPUT .....	34
8.14.5. THERMAL ALARM .....	34
9 MAINTENANCE .....	35
9.1. SCHEDULED MAINTENANCE AND CLEANING THE SPINDLE SHAFT TOOL HOUSING.....	36
9.1.1. CHECK THE CLEANING OF TOOL-HOLDER CONE AND CONICAL HOUSING OF THE ELECTROSPINDLE SHAFT .....	36
9.1.2. PROTECTING THE CONICAL SEAT IN THE SPINDLE SHAFT .....	37
9.1.3. CLEANING THE TOOL-HOLDER CONE.....	37
9.1.4. CHECK THE CONNECTIONS .....	37
9.2. OCCASIONAL MAINTENANCE .....	37
10. TROUBLESHOOTING .....	38
11. DISPOSING OF THE ELECTROSPINDLE.....	38
12. USEFULL ADRESSES.....	38
APPENDIX: ATC71 DRAWINGS AND POWER-TORQUE CURVES.....	39

# 1. INTRODUCTION

## 1.1. PURPOSE OF THE MANUAL

This manual contains important instructions and precautions, and must accompany the electrospindle at all times since it is essential for the safe operation of the electrospindle and operators.

Keep this manual safe, and ensure that all persons involved with the electrospindle know of it and have access to it.

The safety precautions contained herein are designed to ensure the safety of all persons exposed to the residual risks associated with the electrospindle.

The instructions contained herein provide information necessary for the correct operation of the electrospindle, as required by the manufacturer.



Make sure that you read and fully understand all the documentation supplied with the electrospindle to avoid incorrect operation of the unit and unnecessary risks of personal injury.

Keep this manual in a suitable place near the machine, where it will always be easily available to operators for consultation.

	<p><b>THE ELECTROSPINDLE MUST ONLY BE USED FOR THE PURPOSE FOR WHICH IT IS DESIGNED. SAFE OPERATION DEPENDS ON THIS.</b></p> <p><b>SAFETY ALSO DEPENDS ON CORRECT INSTALLATION OF THE ELECTROSPINDLE, AS DESCRIBED IN THE FOLLOWING SECTIONS OF THIS MANUAL.</b></p> <p><b>THE INFORMATION GIVEN IN THIS MANUAL IS THEREFORE ESSENTIAL TO ENSURE THAT THE ELECTROSPINDLE IS INSTALLED AND USED SAFELY AND CORRECTLY.</b></p>
--	--

## 1.2. GENERAL SAFETY SYMBOLS

In this manual, important instructions or precautions are marked with the following symbols:.

	<b>IMPORTANT: Identifies particularly important information.</b>
	<b>WARNING-DANGER: Identifies situations that could be possible electrical shock.</b>
	<b>WARNING-DANGER: Identifies situations that could lead to personal injury.</b>

## 2. WARNING AND SAEFTY PRECAUTIONS



***Teknomotor S.r.l. does not and cannot know how end users will install their electrospindles. The installer or customer must therefore perform risk assessment specific to each installation and application.***

It is also the responsibility of the installer to ensure that adequate guards are provided to prevent accidental contact with moving parts.

The installer and the operator must also bear in mind other types of risk, particularly those associated with foreign bodies, explosive, inflammable, toxic or high temperature gasses.

Risks associated with maintenance operations must also be guarded against. Maintenance must be performed in conditions of maximum safety, and only with the electrospindle fully stationary and switched off.

*Once the electrospindle has been installed in the way decided upon by the installer and/or customer, the machine becomes a "finished machine" as defined for the purposes of the Machinery Directive. Overall risk assessment must therefore be performed on the finished machine and a declaration of conformity produced in compliance with Appendix IIA of the 98/37/CE Machinery Directive.*

### 2.1. RISKS ASSOCIATED WITH IMPROPER USE AND HANDLING

- Never impede the functioning of, remove, modify or in any way interfere with any safety device, guard, or control of individual parts or of the electrospindle as a whole.
- Never place your hands, arms, or any other part of your body near moving machinery.
- Never push objects through the cover grill or into the electrospindle either when it is stationary or when it is operating.
- Do not use the electrospindle in atmospheres or environments where there is a risk of explosion.
- Unless you are duly authorized, never attempt to repair faults or electrospindle malfunctions and never interfere in any way with the electrospindle operation or installation.
- On completion of servicing work for which guards, covers, or any other protections have been removed, always make sure that they have been correctly and securely replaced and are fully functional before re-starting the electro spindle.
- Keep all protection and safety devices in perfect working order. Also make sure that all warning and informative plates, labels and symbols are correctly positioned and perfectly legible.
- When troubleshooting the electrospindle always adopt all the safety precautions listed in this manual for the purpose of preventing injury or damage to persons and things.
- After adjusting any mechanical part, make sure that you fully tighten all screws, bolts or ring nuts you may have slackened or removed.
- Before you start the electrospindle, make sure that all the safety devices are installed and perfectly functional. Do not start the electrospindle if this is not the case, but immediately inform the person responsible for machine safety or your direct superior.
- Make sure that you have and use all the personal protective equipment (PPE) required by law. Do not wear loose or hanging clothing (ties, wide sleeves, etc.).
- Never use types of tool holder that do not correspond to the models those are specify in this manual; this cause the risk of breakage or imperfect hook-up of the tool holder cone.

## 2.2. RISKS SPECIFIC TO ELECTROSPINDLE MAINTENANCE

- During all maintenance and cleaning operations, take great care if a tool is fitted. It is advisable to remove any tool before starting cleaning or maintenance.
- Disconnect the electrospindle from the main supply before carrying out any maintenance operations.
- The electrospindle can still turn under the effect of inertia even after it has been switched off. Make absolutely sure that the electrospindle is not still spinning before starting any maintenance on it.
- Perform scheduled maintenance as specified in this manual to avoid the risk of mechanical failures from advanced wear.

	<p><b><i>NEVER Start any maintenance before making absolutely sure the electrospindle is stopped spinning.</i></b></p> <p><b><i>NEVER Start any maintenance on the electrospindle without first disconnecting it from the electrical power supply.</i></b></p> <p><b><i>NEVER Attempt to clean the electrospindle while it is rotating.</i></b></p>
---	---

## 3. GENERAL INFORMATION

### 3.1. PROPER USE OF ELECTROSPINDLE

The electrospindle is designed to operate as part of a machine.

The frame of the machine to which it is fitted must be sufficiently rigid to provide adequate support for the weight of the electrospindle, and to withstand the stresses caused by machining.

The electrospindles described in this manual are designed for the low-medium power milling and drilling of wood, fiberboard, plastic, aluminum and light alloys.

The product cannot work independently: it is a part of machine, and it is designed to be assembled with other machine parts, or to be incorporated in a machine, so as to form a machine in accordance with Directive 2006/42/EC.

It is forbidden to set the product into operation before the machine into which it is to be incorporated complies with the provisions of Directive 2006/42/EC and subsequent amendments.

### 3.2. RANGE OF APPLICATION

The product has been designed to carry out milling and boring operations in the field of wood and its derivatives, plastic, composite material, aluminum and light machining operations on other metals.

The quick replacement of the shaft unit complete with bearings is possible on every models, using the shaft kit. For further information contact the Teknomotor Technical Office.

All the electrospindles have a mechanical reaction system that almost completely cancels the axial force of the pistons on the bearing during the tool changing phase. It guarantees the long life of the front precision bearings.

### 3.3. GENERAL CONDITION OF SALE

#### FOREWORD

These General Conditions of Sale, except as specifically agreed between the Parties in writing: -shall regulate any present or future sales contracts, proposals/offers as well as any other agreement stipulated between Teknomotor S.r.l.. (hereinafter "Seller" or "TM") and the Buyer or Customer; and



-cancel and replace all previous conditions of sales of TM and constitute the reference basis for all agreements with the Buyer. Any general conditions of sale of the Buyer in contrast with the present provisions are not applicable except if confirmed by the Seller in writing.

### **1) STIPULATION AND EFFECTIVENESS OF THE AGREEMENT**

The signing of a sales contract between the Parties, in whatever form, involves the Buyer's acceptance of these General Conditions of Sale.

The sales contract shall be considered as accomplished when, following receipt of an order conforming to the provisions under Art. 3 below, the Seller has sent the Buyer a written confirmation of it. Any matter not expressly or implicitly dealt with by the sales contract shall be ruled by: i) CISG (United Nations Convention on Contracts for the International Sale of Goods; ii) insofar as not covered by CISG, the law of the country where the Seller has its residence.

### **2) PRODUCT FEATURES**

Any information or data regarding technical specifications and/or characteristics of the products contained in leaflets, pricelists, catalogues or similar documents shall be binding only if expressly mentioned and defined as binding in the sales contract.

The Seller reserves the right to alter the products insofar as, in its sole judgment, modifications are deemed necessary or recommended and providing they do not alter the fundamental features of the products. The Seller is not obliged to adapt, alter or withdraw the products from the market if legal regulations on the application, quality or use of the products are changed subsequently to the accomplishment of the agreement.

### **3) ORDERS**

The Buyer's purchase order, however called, is always subject to written acceptance by TM. Notwithstanding the acceptance of telephone agreements, all orders must be subsequently sent and confirmed by the Buyer via facsimile, surface or electronic mail.

All subsequent order modifications must be notified in writing subject to the Seller's new written acceptance. The Seller's offer is to be deemed firm and irrevocable only if so stated in writing and if it specifically shows a validity term for the provision. Otherwise, it shall be considered not binding or as a mere reply to a quotation request. Any negotiations carried out by agents, licensees, representatives or sales assistants of the Seller are not binding for the latter until receipt of the Seller's express confirmation. Exclusively in case of materials not included in the Catalogue, i.e. in case of materials for which special agreements have been met between Teknomotor S.r.l. and the Customer, cancellation of the order by the Buyer involves TM's right to withhold any deposits paid by the Customer or to apply a penalty amounting to 20% of the value of the order, notwithstanding the Seller's faculty to ask for further damages.

### **4) DELIVERY TERMS AND DELAYED DELIVERY**

Except if otherwise agreed upon in writing, sales are made "EX-WORKS" even when the full or partial shipment is organized by the Seller. All the delivery terms mentioned by the Seller are to be considered as purely indicative except if expressly mentioned as binding in writing. In case of non-fulfilment of the Customer's settlement obligations, the Seller shall have the right to change delivery terms. Delivery terms start from the date of receipt from the Seller of the deposit as provided by the sales contract. Any delay in delivery shall not in any case provide a reason for the Buyer to ask for damages, and the full effectiveness of the sales contract shall remain unchanged.

### **5) TRANSPORT, TRANSFER OF RISKS, FAULTS AND COMPLAINTS**

In default of other agreements, the Seller shall choose the type of transport to be adopted, which is always at the Buyer's expense. The goods travel at the Buyer's risk, and the Seller waives any responsibility therefore from the moment the goods are released to the first carrier within the boundaries of Italy. Upon the Buyer's demand, the Seller may insure the goods against damage caused during transport. However, the Buyer must duly check the goods as soon as they have reached the Buyer's premises.

Any claim relating to package conditions, quantity, number or external appearance of the products ("obvious flaws") shall be notified to the Seller by registered letter (previously sent by facsimile) within eight (8) days from the date of receipt of the products, containing a detailed list of flaws and non-conformities. Later claims or claims not conforming to this clause shall be rejected.

Any claims relating to faults which could not be detected by accurate checking at the moment of receipt ("latent defects") shall be notified to the Seller by registered letter (previously sent by facsimile) containing a detailed list of faults and non-conformities within eight (8) days from the date of detection of those faults and anyway no later than twelve (12) months from delivery. Failure to observe these conditions shall lead to the rejection of such claims.

Any return of the goods by the Buyer shall only be accepted if previously authorized by the Seller. In case the Buyer has used the goods or altered their condition in such a way that the Seller cannot check them, the Buyer shall have no right to make any claim. Whenever a claim has resulted to be unfounded, the Buyer shall also refund the Seller for any costs incurred for the checking of the products. It is understood that any claim or dispute directly or indirectly relating to the products shall give the Buyer no right to interrupt or delay payments of the products involved nor of any other supplies with pending payments.

## **6) PRICES AND PAYMENTS**

All prices are meant EX-WORKS (Seller's premises). Prices shall be increased of the applicable value added tax and any other enforceable tax.

Prices are inclusive of normal packing, whereas they do not include customs duties, transport or insurance costs.

Current prices are mentioned in observance of the Seller's specifications and remain valid until the relevant pricelist updating.

Notwithstanding the above, the Seller reserves the right to alter prices in the short term in case of increase in costs applied by the Seller's own suppliers.

In case of increase in raw material costs, the Seller is entitled to update prices provided the Buyer is informed of such updating, and the Buyer shall have the right to cancel orders within 3 days from receipt of such notification.

Payments shall be addressed by the Buyer to the Seller's premises no later than the terms established by TM and made by bank transfer following the Seller's instructions. Invoices shall be paid in full with no deductions except if justified by a Credit Note issued by the Seller.

In case of delayed payments, even of one single installment, the Buyer's right to deferred terms shall cease without any formal notification by the Seller as provided by Art. 1186 of the Italian Civil Code, and the Buyer shall pay the Seller a penalty interest amounting to the applicable rate as provided by the Law plus 8%, within the threshold admitted by Act no. 108/96, notwithstanding any further claims for damages that the Seller may make.

## **7) LIEN AGREEMENT**

The ownership of the products shall only be transferred to the Buyer after full payment of the goods supplied including any interests, if due. The Buyer undertakes to stock such goods separately and with due diligence and to mark them clearly as the Seller's property. The Buyer also undertakes to assist the Seller in taking all necessary measures to protect the Seller's rights.

This lien agreement does not affect the transfer of risks as stated under 5 above.

If the law of the State where the goods are stored does not admit the right to retain ownership, a form of guarantee similar to this and enforceable in that State shall be applied. If, in order to make this guarantee enforceable, the Buyer's action is required, the Buyer shall take all necessary measures to adopt and maintain this guarantee.

## **8) WARRANTY**

Within the limits of the following provisions, the product is guaranteed for one (1) year (12 months) against material, working and manufacturing faults. Any guarantee on faults not to be attributed to the Seller is excluded. During the guarantee period, starting from the day of transfer of risks, the Seller shall only have the obligation, at its own discretion, to either i) repair any faulty products on the spot, or ii) repair any faulty

parts free of charge provided the product or part of it has been returned, or iii) send a product or part of it similar to the faulty one as a replacement. Whenever the Seller asks for any faulty goods to be returned for replacement or repair, the Buyer assumes, except if otherwise agreed, any transport freight or risk (delivery "carriage free").

The Seller's responsibility is limited to faults arising in the usage conditions as specified in the sales contract and upon correct use of the parts involved. It does not cover, in particular, any faults deriving from wrong installation, maintenance or repair made by anyone other than the Seller or the Seller's authorized staff, nor any alterations made without the Seller's written consent or due to normal wear and tear. Except in the case of willful misconduct or gross negligence, the Seller shall only be bound, in case of vices, quality loss or non-conformity of the products, to repair the same and supply replacements for them as above specified.

It is agreed that the above guarantee, i.e. the Seller's obligation to repair or replace the products, incorporates and replaces any guarantee or liability as provided by the law and excludes any other contractual or tortious liability however arising from the finished products, including, without limitation, refund of damages, gain loss, collection campaigns, idle time losses, loss of clientele or damaged reputation, etc.

The products or their faulty parts which have been replaced according to the provisions stated herein shall be made available to the Seller for the time necessary for checking.

The greatest liability of the Seller, also in case of non-predictable damage, shall in no case exceed the price of the faulty product. For no reason shall the Buyer ask for damages for interruptions of its business activity.

In no case Teknomotor S.r.l. or its suppliers shall accept any responsibility for damage (including but not only, damage to the unit, damage incurred for lost production and income, down-time in manufacturing, loss of information or other economic losses) deriving from the use of Teknomotor products, even if Teknomotor has been advised of such risks in advance.

The Seller shall not accept any return of goods if not previously authorized in writing. The goods which have been authorized for return shall be accompanied by a relevant DDT (Document of Transport, or equivalent), a description of the problem, and a specific indication of how the product was used. In case the Seller has committed itself to repair the product, the cost for its shipment back to the Buyer is entirely at the Buyer's charge.

The warranty becomes automatically null and void if the customer fails to notify Teknomotor S.r.l. in writing of any faults found in the electrospindle within 15 days of their occurrence. The warranty likewise becomes null and void if the customer fails to permit the electrospindle seller to perform all necessary checks and tests, and if, when the seller requests the return of the defective electrospindle, the customer fails to do so within two weeks of the request.

The warranty does not cover faults arising from wear of parts normally subject to continuous or rapid wear (e.g.: seals, belts, bearings, etc..). In particular Teknomotor S.r.l. provides no guarantee as to the working life of the unit's bearings since this depends on a number of factors such as tool balance, type of machining operation, impacts, and/or other mechanical stresses not specified by the customer.

Dimensioned drawings and photographs are provided only for information purposes and to facilitate understanding of text.

Teknomotor S.r.l. has a policy of constant development and improvement, and reserves the right to make functional and stylistic modifications to its products, to change the design of any functional or accessory part, and to suspend manufacturing and supply without notice and without obligation to third parties. Furthermore, Teknomotor S.r.l. reserves the right to make any structural or functional change to the units, and to change the supply of spare parts and accessories without any prior notice.

Teknomotor S.r.l. declines all responsibility for non-compliance of the electrospindle caused by failure to follow the precautions and instructions given in this manual or by improper use or handling of the electrospindle. The customer has the right to replacement of all parts shown to be defective, unless the defects are caused by unauthorized tampering, including the fitting of non-original Teknomotor spare parts and/or the replacement of parts not described or authorized in this manual unless authorized beforehand and in writing by Teknomotor S.r.l.

## **9) FORCE MAJEURE**

Either Party shall have the faculty of suspending the execution of their contractual obligations when such execution is made impossible or unreasonably costly by an unpredictable event which goes beyond the

Parties' will such as, for example, suppliers' non-performance of duties, energy or raw material shortages, strikes, lock-outs, declared or non-declared war, civil war, terrorist acts, embargoes, etc.

The Party wishing to enforce this clause shall immediately notify the other Party in writing of the beginning and the end of such circumstances of force majeure.

Whenever the force majeure event lasts more than 6 weeks, either Party shall have the right to rescind the contract with a written notice sent to the other.

#### **10) LIABILITY**

The Seller shall not be held liable for damage or accidents to things, people, or loss of gain deriving from the use of its motors.

#### **11) COOPERATION BETWEEN THE PARTIES**

The Buyer shall promptly inform the Seller of any claim forwarded to the Buyer by its customers or by third parties regarding the products delivered or intellectual property rights on them.

#### **12) SEVERANCE CLAUSE**

Whenever one or more provisions contained herein are declared void based on the Buyer's local legislation, the Buyer is obliged to promptly inform the Seller and, in such case, those void provisions shall be modified in writing by adding an appendix hereto which shall be construed in such a way as to have the nearest possible financial purpose of the original one(s), whereas the provisions not declared as void shall remain binding.

#### **13) INTELLECTUAL PROPERTY**

Except if otherwise agreed between the Parties, the Buyer does not acquire any intellectual property right on any software packages and/or drawings released to it by the Seller. The Buyer undertakes to treat any information received by the Seller as confidential. The Seller remains the only owner of any intellectual property right relating to the products.

#### **14) TRANSFER OF RIGHTS TO THIRD PARTIES**

The Buyer shall not transfer or assign this agreement or any of the rights originating from it to any third parties without the Seller's written consent.

#### **15) LANGUAGE OF THE SALES CONTRACT**

The sales contract and the present General Conditions of Sale are originally drawn up in Italian and have full value in this language, whereas any versions in other languages shall be intended as informal translations. Only the version in Italian shall constitute a reference in case of disputes relating to the content or effectiveness of a clause contained herein.

#### **16) PLACE OF JURISDICTION**

The applicable law is the Law of Italy. Any dispute arising directly or indirectly from the contractual relationship between the Parties shall be exclusively submitted to the Court of Belluno, Italy, notwithstanding the faculty of the Seller only to file a lawsuit before the Buyer's competent Court.

## 4. TECHNICAL SPECIFICATIONS

### 4.1. THE MAIN PARTS OF THE ELECTROSPINDLE

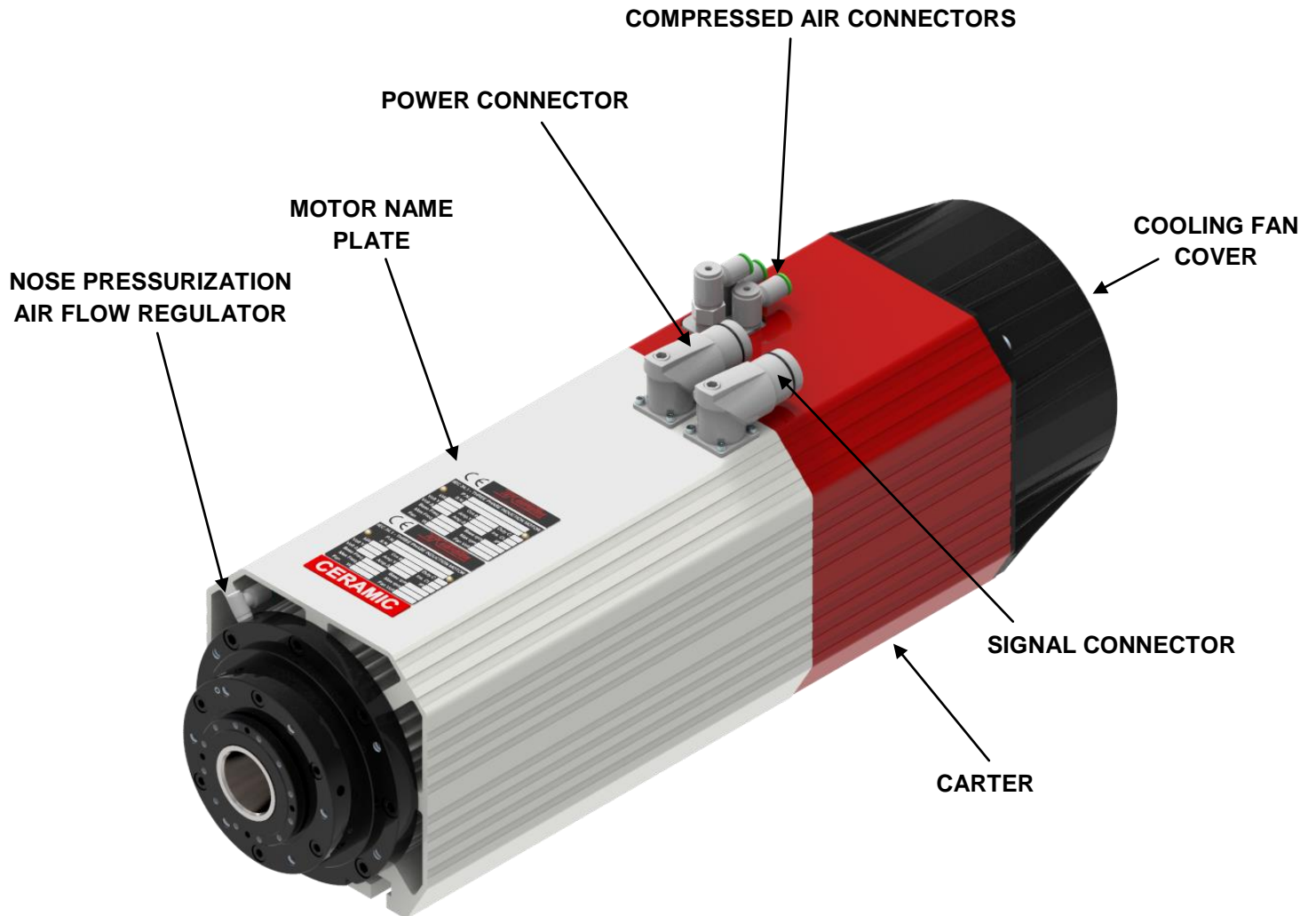

Fig. 1 Main part of the electrospindle

## 4.2. IDENTIFYING THE MOTOR DATA FROM THE NAME PLATE

The part number (P.N. or TYPE) and the serial number (S.N.) are printed on the name plate and they are only way to identify the electrospindle recognized by the manufacturer. For this reason they must be kept legible throughout the unit's working life. The place of the name plate and the disposition of data in the name plate could be different model by model.

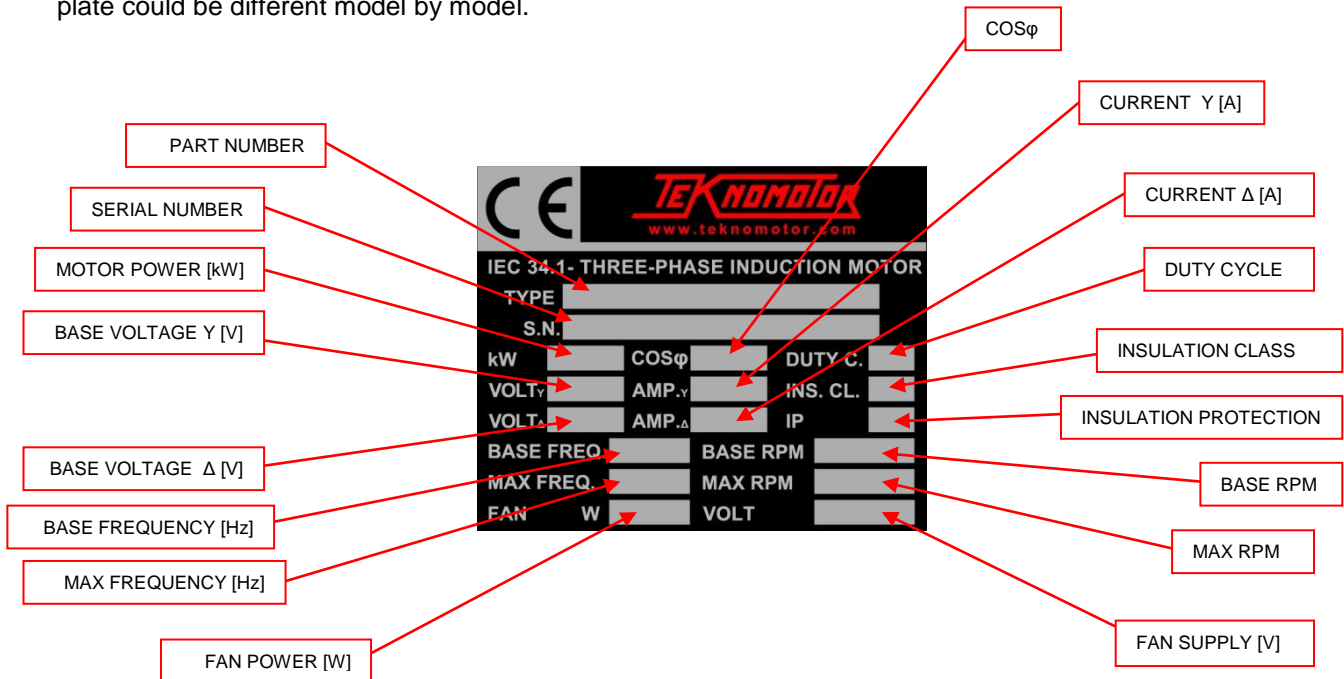

Fig. 2 Typical Teknomotor electrospindle nameplate

## 4.3. GENERAL VIEWS, OVERALL DIMENSIONS AND PERFORMANCE

See attached documents. If the document is not available please contact Teknomotor technical office.

## 5. TRASPORT, PACKAGING, UNPACKAGING AND STORAGE

### 5.1. PACKAGING AND LIFTING

- Lifting and moving the electrospindle can create situations of risk to persons nearby. Always follow the instructions provided by this manual, follow all possible safety instruction for the handling of heavy loads. Always use suitable lifting equipment. The responsibility for the safety of the people involved in handling, moving and lifting operation is of the customer.
- Installation and assembly work must be performed only by specialist technicians.
- Always use great care in lifting and moving electrospindles and their components. Avoid impacts which can damage the body or the shaft or the bearings of the electrospindle.

	<p><b><i>It is the responsibility of the customer to ensure that the lifting equipment used is suitable for the purpose in terms of functioning and load capacity.</i></b></p> <p><b><i>Never lift the electrospindle by its fan cover. This can break, damaging the electrospindle and possibly causing personal injury.</i></b></p> <p><b><i>Never drill parts of electrospindle to attach elements useful to move electrospindle.</i></b></p>
---	--

#### Load characteristics

The load is to be considered too heavy for a single person when:

- It weights for more than 30 kg for men
- It weights for more than 20 kg for women

Do not drill the electrospindle to fit any hoisting tool.

### 5.2. STORAGE

If the electrospindle is to be stored for any length of time, make sure that it is protected against the elements and in particular against damp, dust, and other forms of damage by the atmosphere or storage environment.

**STORAGE TEMPERATURE: from -5°C to +55°C**  
**NON-CONDENSING RELATIVE HUMIDITY: from 5% to 15%**

	<p><b><i>The storage time of Teknomotor electrospindle is 12 months. After this time-limit the product must be inspected by an authorized Teknomotor service. If you need more information please contact Teknomotor S.r.l..</i></b></p>
---	--

## 6. INSTALLATION

### 6.1. CHECKING FOR DAMAGE

Before starting installation, check:

- That no part of electrospindle has been damaged during transport and/or handling,
- That there is no sign of damp or water inside the connection terminal board,
- That the terminal board and its cover are not damaged in any way.



***IF THE ELECTROSPINDLE IS DAMAGED INFORM IMMEDIATELY THE TRANSPORTER AND TEKNOMOTOR S.R.L.***

### 6.2. PROVISION OF ON SITE INSTALLATION EQUIPMENT

All work in preparation for installation of the electrospindle is the responsibility of the customer (e.g. preparation of electrical power supplies, compressed air pipe etc.).

Make sure that the electrical power line to the electrospindle is of adequate section and power. Connection of the unit to the power supply must only be done by qualified electricians. The customer is responsible for all parts of the electrical power supply to the electrospindle.



***ATTENTION: the customer is expressly reminded that the electrospindle must be correctly connected to earth. Furthermore, the earth connection must comply with applicable regulations in the country in which the unit is installed and must be duly checked and tested by a qualified electrician.***

### 6.3. MECHANICAL CONNECTIONS

#### 6.3.1. POSITIONING OF ELECTROSPINDLE

When choosing the location for the electrospindle, ensure a clearance of at least 100mm from the grille of the electric fan, so as not to obstruct the flow of cooling air.

The electric fan protection is IP21; (the electrospindle protection is IP54). Ensure that the electric fan sucks in sufficient air for its IP protective rating, as otherwise it may be damaged.

#### 6.3.2. ELECTROSPINDLE RESTING SURFACE

The resting surface where the electrospindle is fixed must have a planarity of less than 0.02mm.

#### 6.3.3. TOOL CHANGE SYSTEM

The tool holder magazine must position the cones with a concentricity error between the spindle shaft axis and the tool holder cone axis of 0.2mm.



### 6.3.4. FIXING ELECTROSPINDLE

The electrospindle should be fixed to the slide or the spindle holder support, using M8 screws and T-slot nuts with a tightening torque of 20Nm. The maximum protrusion allowed for the fixing screw is 15mm, as shown in figure; greater protrusions can deform the framework of the electrospindle and produce incorrect blocking, with negative consequences for the precision of the machining operation and the safety.

For the correct alignment, use the tang slot between the two T-slots.

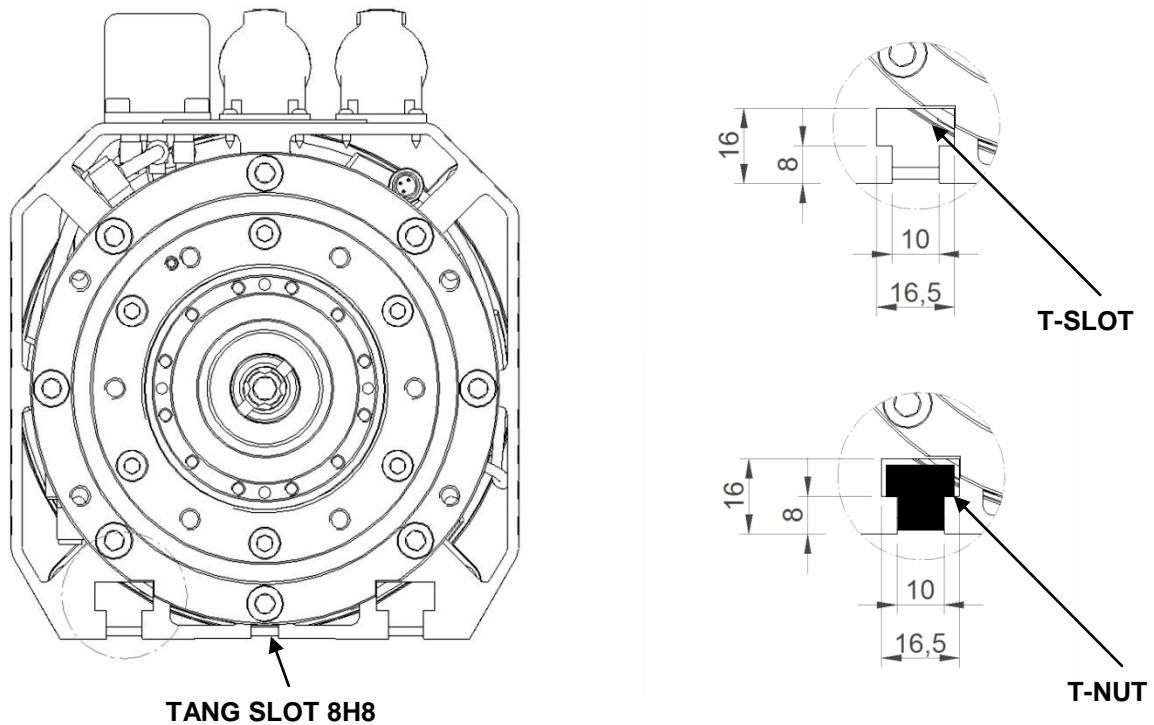





Fig. 3 Fixing slots

	<p><b>Maximum protrusion of the screw: 15mm.</b></p> <p><b>Ensure a gap of at least 1mm</b></p> <p><b>Greater protrusions deform the framework of the electrospindle, compromising the precision of the machining operation and also the safety.</b></p> <p><b>Use the tang slot 8H8 to align the electrospindle.</b></p>
	<p><b>While fixing the unit in place, take care not to block off the cooling fan grill or otherwise impede the flow of cooling air. Always leave the maximum gap around the unit specified in the overall dimension drawings (100mm).</b></p>

## 6.4. PNEUMATIC CONNECTION

### 6.4.1. AIR PURITY

	<p><i>Supply the electrospindle with compressed air in accordance with ISO 8573-1, classes 2,4,3:</i></p> <ul style="list-style-type: none"> <li>• <i>class 2 for solid particles: solid particles size &lt; 1µm</i></li> <li>• <i>class 4 for the humidity: dew point &lt; 3°C (37.4°F)</i></li> <li>• <i>class 3 for the total oil: concentration of oil &lt; 1mg/m<sup>3</sup></i></li> </ul> <p><i>Failure to comply with these specifications may result in product malfunction. The guarantee is not valid if pollutants are found during repair operations.</i></p>
---	--

	<p><i>Follow the indication below:</i></p> <ul style="list-style-type: none"> <li>• <i>If a lubricated air circuit is present in the machine, it should be insulates from the dry air circuit through a non-return valves.</i></li> <li>• <i>The filters indicated in this section should be installed as near the electrospindle as possible.</i></li> <li>• <i>Taking into account the fact that the efficiency of the filters is &lt; 100%, it is essential that the machine be fed with properly treated air; as a general guide, introduce compressed air with a purity rating complying with ISO 8573-1, class 7, 6, 4:</i> <ul style="list-style-type: none"> <li>○ <i>class 7 for solid particles: solid particles size &lt; 40 µm</i></li> <li>○ <i>class 6 for the humidity: dew point &lt; 10°C (50°F)</i></li> <li>○ <i>class 4 for the total oil: oil concentration &lt; 5mg/m<sup>3</sup></i></li> </ul> </li> <li>• <i>at the end of the working day, empty the pneumatic system to enable the automatic purging of filters.</i></li> <li>• <i>Carry out regular maintenance operations of the filters according to the manufacturer's indications, and replace them when they are saturated and lose effectiveness (approximately every 6/12 months).</i></li> </ul>
---	--

### 6.4.2. PNEUMATIC CONNECTION DIAGRAM

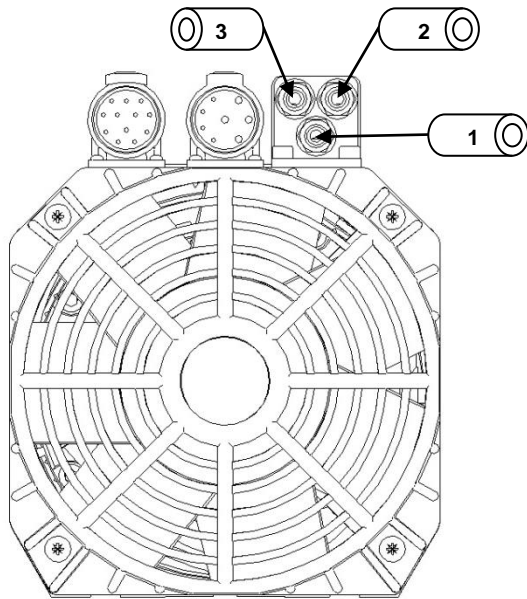

<b>1</b>	Pressurization inlet – 6 bar (87 PSI) (automatic cone clearing included)
<b>2</b>	Tool holder hook-up inlet 6 bar (87 PSI)
<b>3</b>	Tool holder release inlet 6 bar (87 PSI)
<b>4</b>	Factory air supply inlet > 6 bar (87 PSI)
<b>5</b>	Compressed air filter/drying: 5µm
<b>6</b>	Compressed air filter/drying: 0.1µm
<b>7</b>	Pressure regulator – 6 bar (87 PSI)
<b>8</b>	Pressure switch
<b>9</b>	5/2 monostable solenoid valve
<b>10</b>	Internal cone clearing valve
<b>11</b>	Nose pressurization flow regulator
<b>A</b>	Cone clearing air outlet
<b>B</b>	Nose pressurization air outlet



***The cylinder is double-acting: it must be kept under pressure to maintain the piston in the upper position, far from the rotating parts.***

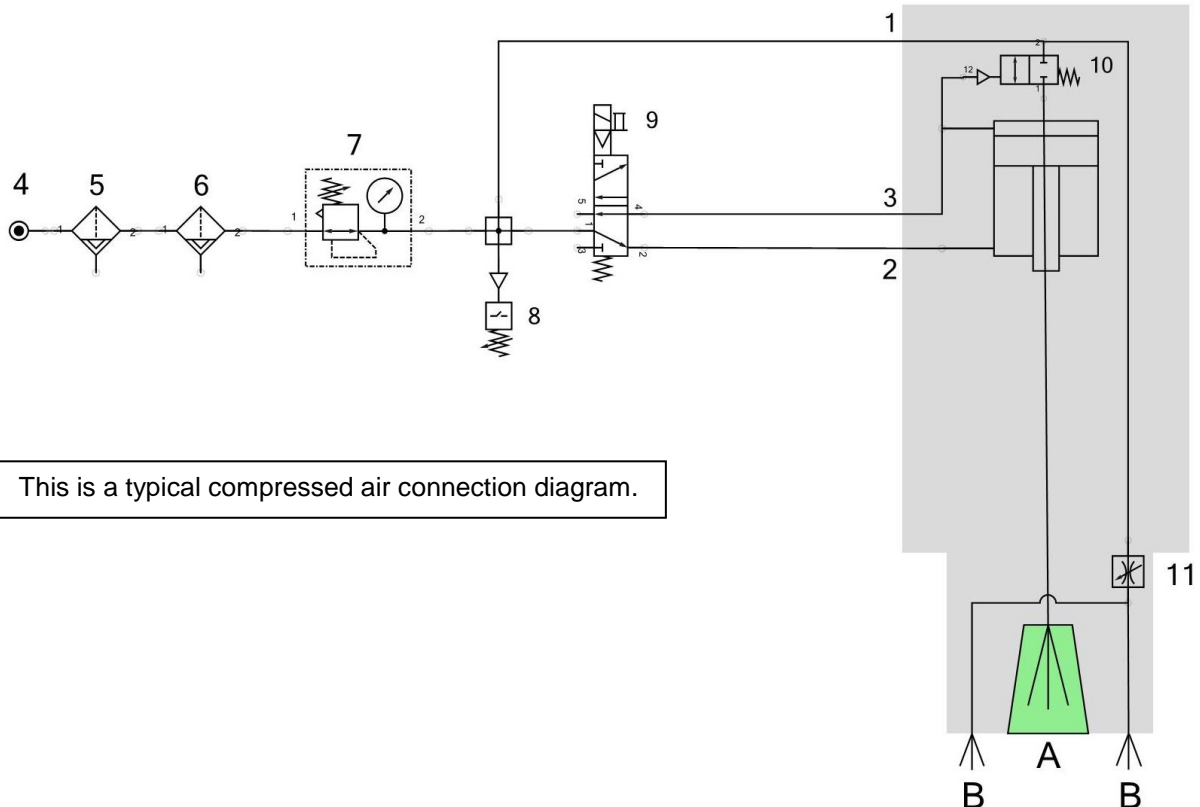

This is a typical compressed air connection diagram.

## 6.5. PNEUMATIC SPINDLE NOSE CLEANING

The electrospindle is equipped with an automatic pneumatic system that blows through the shaft when the gripper is open. When the 5/2 electric valve is excited the pressure in the pipe n°3 grows up. So the piston opens the gripper and automatically the pneumatic valve opens the circuit which blows the air through the shaft (see 6.4.2). The high pressure air cleans the cone and the gripper. During all the phases of tool changing the pneumatic valve remains open to assure that the dusty particles don't come inside the cone.

## 6.6. NOSE PRESSURISATION

The electrospindle nose has pneumatic seals that blocks every dust and coolant particles inside the bearings. The pressurization must be active during all the time even when the electrospindle is not running.

## 6.7. ELECTRICAL CONNECTIONS

See data sheet and inverter configuration.



**ATTENTION: always use power cable of adequate cross section for the rated current of the electric motor.**

**Never fit or remove connectors with the electrospindle powered on.**

### Protections for electric motor

All electrical circuits must be protected against damage resulting from faults or malfunctions due to: short-circuit overloads; overload current; interruption or reduction of the supply voltage; excessive speed of machinery components; overheating in case of a high number of on-load starts. For the safety of people and/or objects, protections must be provided against direct contact with live parts and indirect contact with parts which are not live under normal conditions but which may become so in the event of a fault. If the motor shaft stops because of current cut off, it is recommended to take precautions for the stop of the rotation in the opposite direction; if the safety of the machine depends on the direction of the motor shaft, it is recommended to take precautions to avoid an inversion of the phases; in case, the direction of rotation must be indicated with a visible label.

See the inverter manual to determine the kind protections of short-circuit over-current and overload current.

### 6.7.1. LAYOUT OF POWER CONNECTOR

PIN	DESCRIPTION
1	U motor phase
2	V motor phase
3	W motor phase
w	Ground PE
A	Fan (L) 220V
B	Thermal protection
C	Thermal protection
D	Fan (N) 220V



## 6.7.2. LAYOUT OF SIGNAL CONNECTOR

PIN	DESCRIPTION
1	S1 – tool-holder attached correctly
2	S2 – collet open
3	S3 – tachometer
4	Not used
5	S5 – piston upper position
6	0V
7	+24V DC

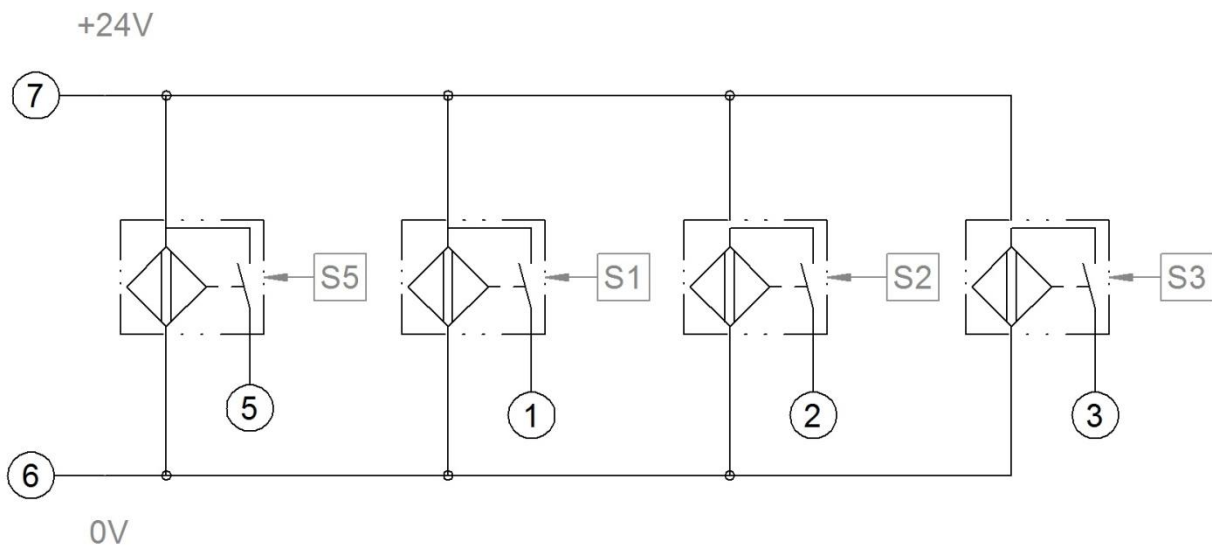

The sensors are PNP NO (normally open).

## 6.8. ELECTRIC FAN

The electrospindle is cooled by a rear mounted electric fan. The fan must be powered up even when the spindle is not operating. The fan is independent of the spindle shaft. This solution gives improved efficiency compared to shaft mounted fans.

	<b><i>The fan must remain ON at all times when the machine is active even if the electrospindle is not operating.</i></b>
	<b><i>The voltage of the electric fan is printed on the electrospindle name plate.</i></b>

## 6.9. TOOL MANUAL RELEASE BUTTON

Sometimes electrospindles have a push button on the electrical box for manual release of the tool. This push button is a simple switch plugged to signal connector.

The following figure shows a typical connection scheme:

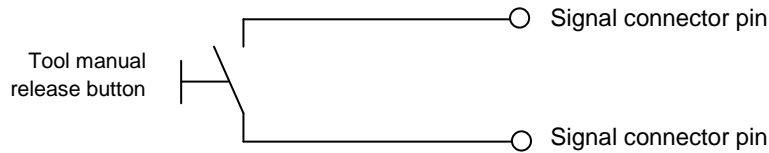

Teknomotor doesn't install the push button on the electrospindle due to the following reasons:

- The push button on the electrical box may cause injuries because it is near the electrospindle hot frame that should warming up during the previous working operations.
- The push button is a simple switch and often it is inconvenient to get to push because the electrospindle is far from the operator, it is better to install the push button near the operator.
- The push button needs a circuit to release the tool.

The following figure shows a typical circuit for tool release:

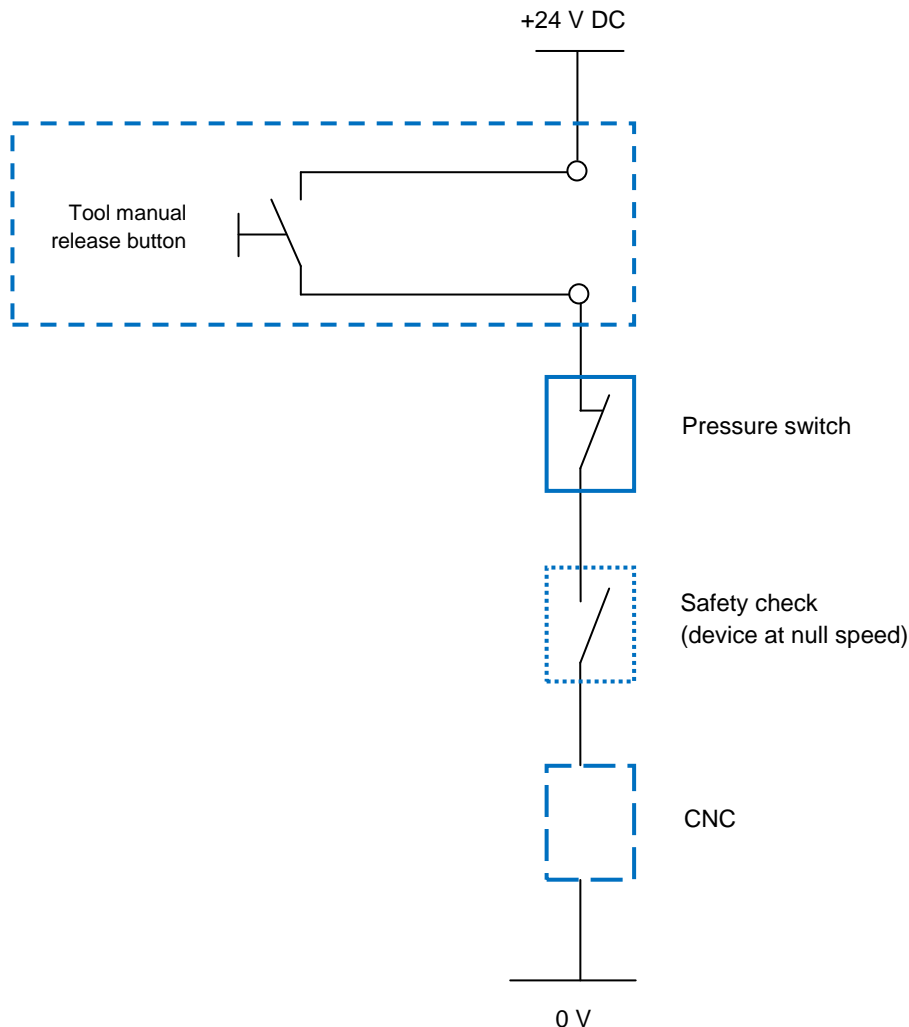

## 7. GENERAL CHECKS AFTER INSTALLATION IN THE MACHINE AND PRIOR START-UP

### 7.1. CHECKING ON THE ELECTROSPINDLE PRIOR TO START-UP

#### Position

- Make sure that there is sufficient space behind the electrospindle cooling grill, at least 100mm.

#### Electrical connection

- Make sure that the electrospindle earthing cable or earthing terminal is connected to the machine earth.
- Make sure that the signal from the motor's thermal protection is suitably processed and connected in series with the machine's stop circuit.

#### Programming the inverter

- Make sure that the maximum supply voltage value corresponds to that specified on the electrospindle motor data plate (see section 4.2).
- Make sure that the frequency value at maximum voltage corresponds to that specified on the electrospindle motor data plate (see section 4.2).
- Make sure that the maximum frequency value corresponds to that specified on the electrospindle motor data plate (see section 4.2).
- The inverter must be programmed with the ratio V/f constant.
- Contact Teknomotor S.r.l. if you need to check other inverter parameters.

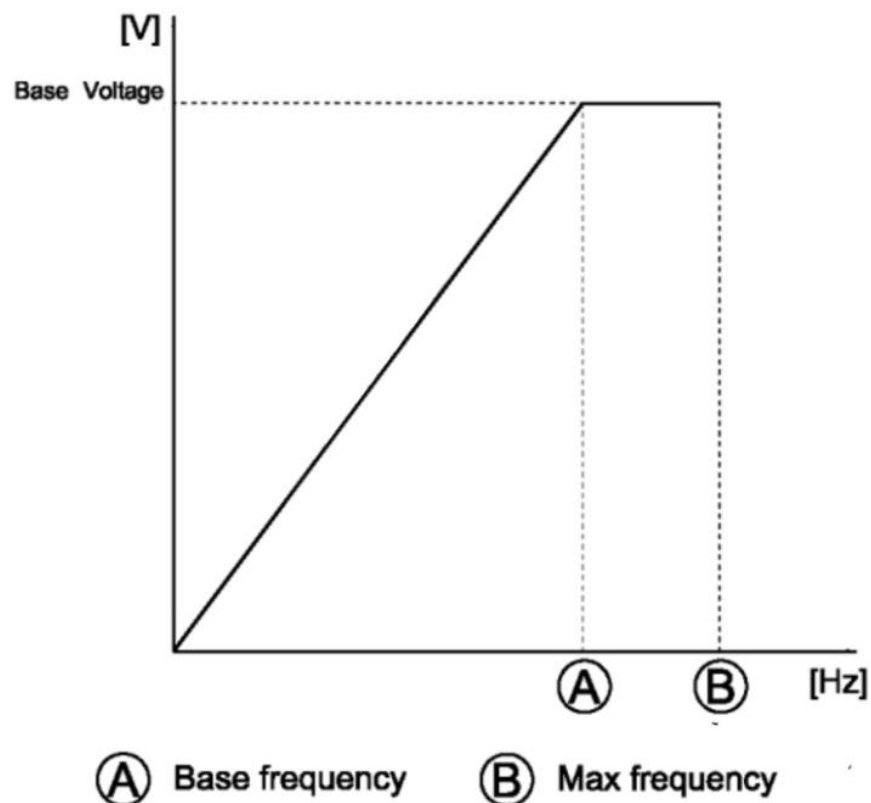

Fig. 4 V/F pattern



**ATTENTION: wrong inverter setting could cause instantaneous damage on the electrospindle.**

## 7.2. CHECKING ON THE ELECROSPINDLE AT THE TIME OF FIRST START-UP

- Check the direction of rotation of spindle shaft corresponds with the NC and with the direction symbol on the body of the electrospindle; the wrong direction of rotation of spindle shaft causes unscrewing of nut.
- Run the electrospindle briefly without load to warm it up (see section 8.4)
- Make sure that the draft of cooling air produced by the fan comes out from all four air channels in the nose of the spindle.

## 7.3. CHECKING ON THE ELECTROSPINDLE BEFORE RUNNING IT



***The cylinders of these electrospindles are double-acting: it is necessary to keep the cylinder under pressure to maintain the piston at the upper end stop, far from fast rotating parts.***



***Never run even for small test without air supply. The motor can be damaged, if cylinder move from upper position to a lower position. In the lower position the cylinder make contact with the housing of the ATC to prevent load of cylinder to work on ball bearings. If the motor is running and the cylinder move to lower position it will result in catastrophic failure or the motor.***



## 8. OPERATION OF THE ELECTROSPINDLE

### 8.1. CLIMATIC LIMITATIONS

Unless specified otherwise, all Teknomotor electrospindles are designed to operate within the following ranges:

- Altitude not above 1000 m above sea level
- Maximum ambient air temperature not above 40°C
- Minimum ambient air temperature not below 10°C

### 8.2. FORECAST AND NON FORECAST USE

Teknomotor electrospindles have been designed to be mounted on a machine tool for the chips removal; it is the customer's responsibility to have any necessary interventions carried out on said machinery in order to render it compliant with Directive 98/37 EC.

The electrospindle can only be used if the machine on which it is going to be mounted has been rendered compliant with Directive 98/37 EC.

Use the electrospindle only to machine materials specified to Teknomotor when placing the order to avoid any inconvenience whatsoever. Generally the electrospindle cannot work in foggy environments or with coolant jet directly in the spindle nose. Specific pneumatic sealed electrospindle are available for such environments (contact our technical office for more information).

Teknomotor S.r.l. declines all responsibility for non-compliance of the electrospindle caused by failure to follow the precautions and instructions given in this manual or by improper use or handling of the electrospindle.

Forecast use:

- Use the electrospindle only for working materials specified at order placement, in general wood, pvc, aluminum.
- Always use sharpened and balanced tools.
- Always use extra precision collets.

Non forecast use:

- Never use the electrospindle in foggy environments or with coolant jet in the spindle nose.
- Never use the electrospindle with too heavy or too long tools
- Before starting the electrospindle always fix it to the machine tool chassis. Never use the electrospindle as a manual tool.
- Never run the electrospindle faster than the maximum speed written on the electrospindle name plate.
- Never run the electrospindle faster than the maximum speed written on the tool body.

In case of any doubt regarding the correct use of electrospindle do not hesitate to contact our technical office.

### 8.3. RUNNING IN

The electrospindle made running in process in the factory, prior to shipment. This ensures correct distribution of the long-life grease in the bearing races. The running in cycle also includes comprehensive testing of all electrospindle electrical mechanical parts.

Before using the electrospindle for the first time it is necessary to operate a short running in to guarantee a correct distribution of the grease inside the bearing.

- Step 1: run the electrospindle at a speed of 3000 rpm for 2 minutes;
- Step 2: increase the speed of 3000 rpm every 2 minutes up to the maximum speed written on the name plate of electrospindle.

Check the temperature of electrospindle nose, if it exceeds the 50°C stop the electrospindle. Restart the running in from the last speed when the electrospindle temperature reaches the ambient temperature.

## 8.4. WARMING UP

Every day, when the electrospindle is started up for the first time, leave it warm up slowly without load. This ensures that the bearings reach their running temperature gradually, and that the bearing races expand evenly.

The following warming up cycle is recommended:

50% maximum plated speed for 5 minutes.

Warm the electrospindle up before machining whenever the machine has been left idle long enough for it to cool down to ambient temperature.

## 8.5. TOOL-HOLDER LOCKING AND EXPULSION DEVICE

The blocking and expulsion of the tool-holder is carried out by the movement of a pneumatic piston, it is activated by compressed air.

The tool-holder is mechanically blocked with elastic springs.

Electrospindle model	Axial force on the tool-holder	Expulsion of the tool-holder cone
ISO 30	3200N ± 10%	0.5 – 1.5 mm

The electrospindles have a mechanical reaction system that neutralizes the axial force of the piston on the shaft during the tool changing phase, guaranteeing the integrity of the angular contact bearing.

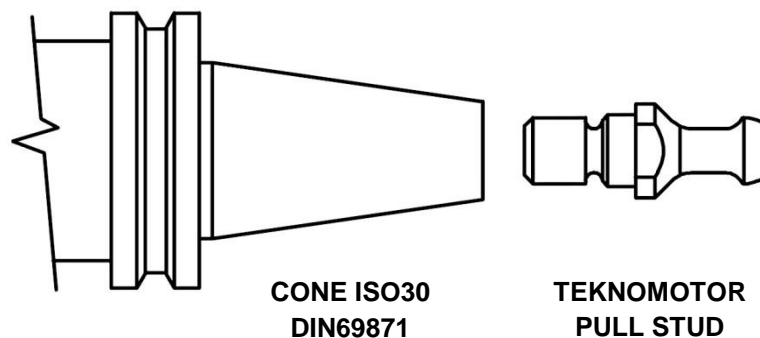

## 8.6. TOOL-HOLDER CONE



- The taper must respect standard DIN69871 for ISO30;
- The tool-holder ISO30 cone must have AT3 precision rating;
- At maximum rated speed of the electrospindle, the level of dynamic balancing must be G 2.5 or better (ISO 1940 standard);
- The balancing must be carried out with the tool-holder assembled (cone, mill, collet, ring nut, tool);
- The pull stud must be the one supplied by Teknomotor.

## 8.7. INSTALLATION OF THE PULL STUD ON THE ISO30 CONE

- Carefully clean the pull stud and the its housing in the ISO30 cone.
- Cover the thread of pull stud with thread-blocking liquid (LOCTITE 270 or equivalent product).
- Tighten the pull-stud to the cone with a torque of 62 Nm.
- Leave the cone to rest until the thread- blocking liquid becomes solid (see the manufacturer's instructions).



	<b><i>The use of non-original Teknomotor pull stud, or its non-correct installation, may cause the tool-holder accidental release.</i></b>
	<b><i>It is forbidden to use ISO tool-holders not conforming to the condition described above; failure to observe these instructions represents a source of risk of breakage or incorrect hook-up of the tool-holder cone, with serious risk for the user.</i></b>

## 8.8. GENERAL RACCOMANDATION FOR THE TOOL HOLDER CONES

- The choice of tool-holder is determining factor for safety purpose.
- The taper surface of the tool-holder and its housing on the spindle shaft must be kept thoroughly clean in order to permit secure hooking-up.
- During machining operations, be sure to avoid any contact between the non-cutting rotating parts and the piece being machined.
- The seat of the tool-holder cone must always be protected against any impurity that may come in.
- At the end of the working day, always remove the tool-holder cone from the electrospindle, to avoid any problem of it sticking. Replace it with a clean tool-holder cone at room temperature, to protect the inside of the electrospindle against the outer environment.



## 8.9. TOOL MOUNTING – TOOLHOLDER

- 1) Use only fully sharpened tools, and make sure that they are securely locked in the spindle.
- 2) Never use bent or damaged tools, chipped tools, or tools that are not perfectly balanced.
- 3) Do not exceed the speed marked on the tool body or specified in the tool user manual.
- 4) Always ensure that the following essential requisites are met before using any tool at high speed:
  - The tool must be of compact, short, and lightweight design
  - The tool must be a precision instrument, and any inserts must be held into a high degree of security
  - The tool must be balanced and must mate symmetrically with the tool holder
  - The cutting surfaces of the tool must be located near its centre of rotation

	<b><i>The recommended balancing degree for tools exceeding the speed of 6000 rpm is G2.5 (ISO 1940 standard) @ maximum speed.</i></b>
	<b><i>FOR TOOL-HOLDER WITH CONICAL SEAT FOR ER DIN 6499 If the tool protrusion is longer than 80mm use absolutely extra precision collets. Please check section 8.10 of this manual.</i></b>

	<p><b>FOR TOOL-HOLDER WITH CILINDRICAL SHAFT</b></p> <p><i>Unless otherwise requested by the customer, tool-holder with tool engagement key are balanced with the key in place (full key balancing – FK).</i></p>
---	---

Because of the many factors to consider, it is not possible to summarize in table form the diameters and maximum weights of tools for any specific speed.

	<p><i>Always check the maximum operating speed of tools. This is either punched on the tool itself or otherwise specified by the tool manufacturer.</i></p> <p><i>During machining, take great care to avoid contact between non-cutting rotating parts (spindle shaft, tool-holder, tool ring nut, etc.) and the workpiece or other parts of the machine. Accidental contact can lead to damage to the electrospindle or injury to the operator.</i></p> <p><i>Never start electrospindle fitted with tool engagement keys without a tool in place and correctly tightened in the tool holder.</i></p>
	<p><i>The tool edges are very sharp and can provoke serious injuries. always use protection gloves, goggles, clothings, helmets and other personal protection equipment (ppe) during the tool fitting operation.</i></p>

## 8.10. TOOL MOUNTING – TOOLHOLDER WITH CONICAL SEAT FOR ER DIN 6499

The tool mounting is a careful operation because it define the electrospindle life.

	<p><i>Excessive tool run-out causes premature wear of bearings.</i></p>
---	---

Before fixing the tool on the tool-holder:

- Carefully blow with compressed air the tool holder inside taper, the nut, the collet and the tool.
- Clean them with mix thinner-oil (92%+8%) to remove the processing residual if it is necessary use soft paper.
- Fix the collet on the nut and check that it could turn freely.
- Insert them into the inside taper of the tool-holder and screw the nut by hand.
- Insert the tool and check that it could axially move freely.
- Position the tool in order that the collet clamps the tool on the total length of contact.
- Screw the nut with the advised torque using the specific wrench.
- Check the run out of the tool or if it is not possible check the vibration level of the motor.

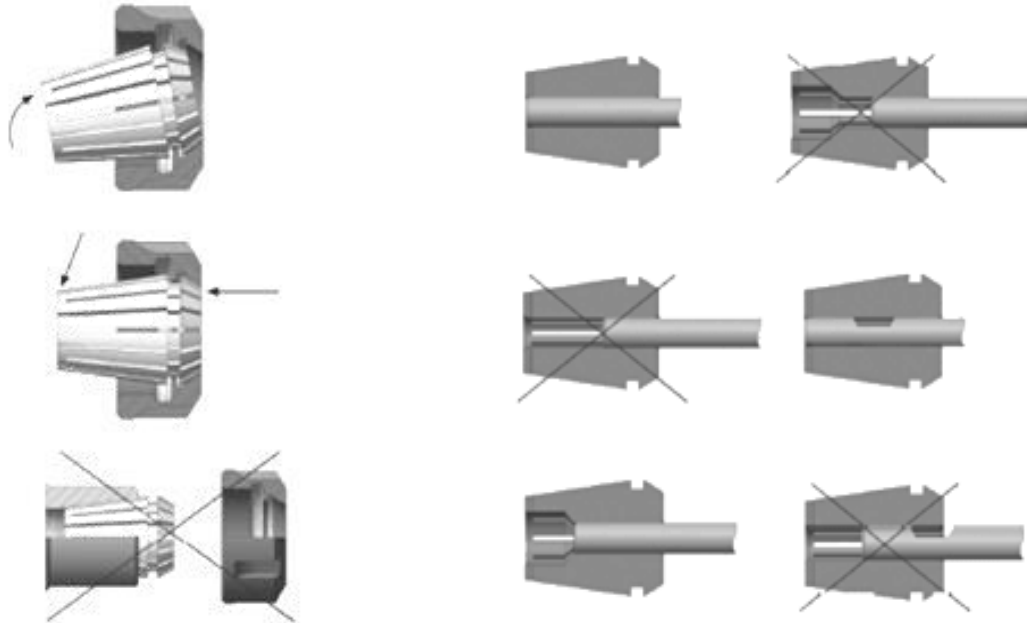

### 8.11. MAXIMUM RUN-OUT AND VIBRATION VALUES

Check that the tool is aligned with the shaft. Use a dial gauge with high resolution (0.001 mm) to measure the tool run-out. The maximum allowed run-out is 0.02mm @ 100mm far from the collet (L1). If it is not possible to measure the tool run-out because of the tool design, use a vibrometer to check the vibration level of the motor. The maximum vibration value should not exceed 2.0-2.5mm/s.

The concentricity values according to DIN 6388 are shown on the following table:

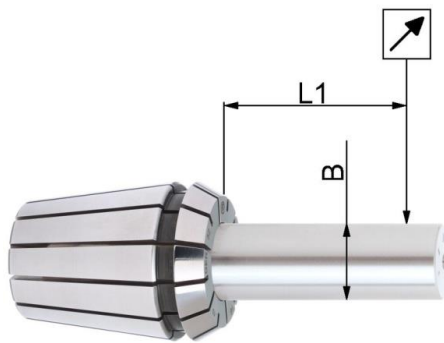

Concentricity collets values				
Ø B mm		L1 mm	DIN6388 mm	Extra precise mm
from	up to			
1.0	1.6	6.0	0.015	0.005
1.6	3.0	10.0	0.015	0.005
3.0	6.0	16.0	0.015	0.005
6.0	10.0	25.0	0.015	0.005
10.0	18.0	40.0	0.020	0.005
18.0	26.0	50.0	0.020	0.005

The run-out values of 3 type of collets on the market are shown on the following table:

The experimental results underline that a heavy tool as a milling tool (Ø 16 mm used on the door machine) needs an extra precise collet.

Excessive tool run-out causes a premature wear of the rear bearings as clearly shown on the above table.



**USE EXTRA PRECISE COLLETS to guarantee a long life of your electrospindle.**

## 8.12. SPEED LIMITS

	<p><i>Observe the maximum rotational speed (rpm) specified by the tool manufacturer.</i></p>
---	--

## 8.13. WHAT TO DO IF THE TOOL IS BLOKED ON THE PIECE BEING WORKED

	<p><i>If the machine goes into emergency mode or stop with the tool blocked on the piece being worked, do not move the spindle along the Z-axis.</i></p>
---	--

Release the piece manually and then carry out the tool changing manually if it is possible.

If it is not possible, proceed in the following way:

- Supply air to the tool changing circuit
- Slowly move the spindle away from the piece, moving it along the Z-axis until the collet opens ("ON" output of sensor S2)
- Check the collet spindle has been freed from the collet
- Move the spindle completely away from the piece being worked
- Remove the blocked tool manually.

## 8.14. SENSORS

The electrospindle is equipped with inductive sensors for monitoring its status, and a thermal alarm to protect the electric coils.

SENSOR	INFORMATION
S1	Tool-holder cone attached correctly
S2	Collet open
S3	Tacho – shaft stopped
S5	Piston at upper position
Thermal alarm	Engine overheated – stop the electrospindle

All the sensors are equipped with output light that turns on when the sensor output turns on. So it is easy to see the functioning of the sensors.

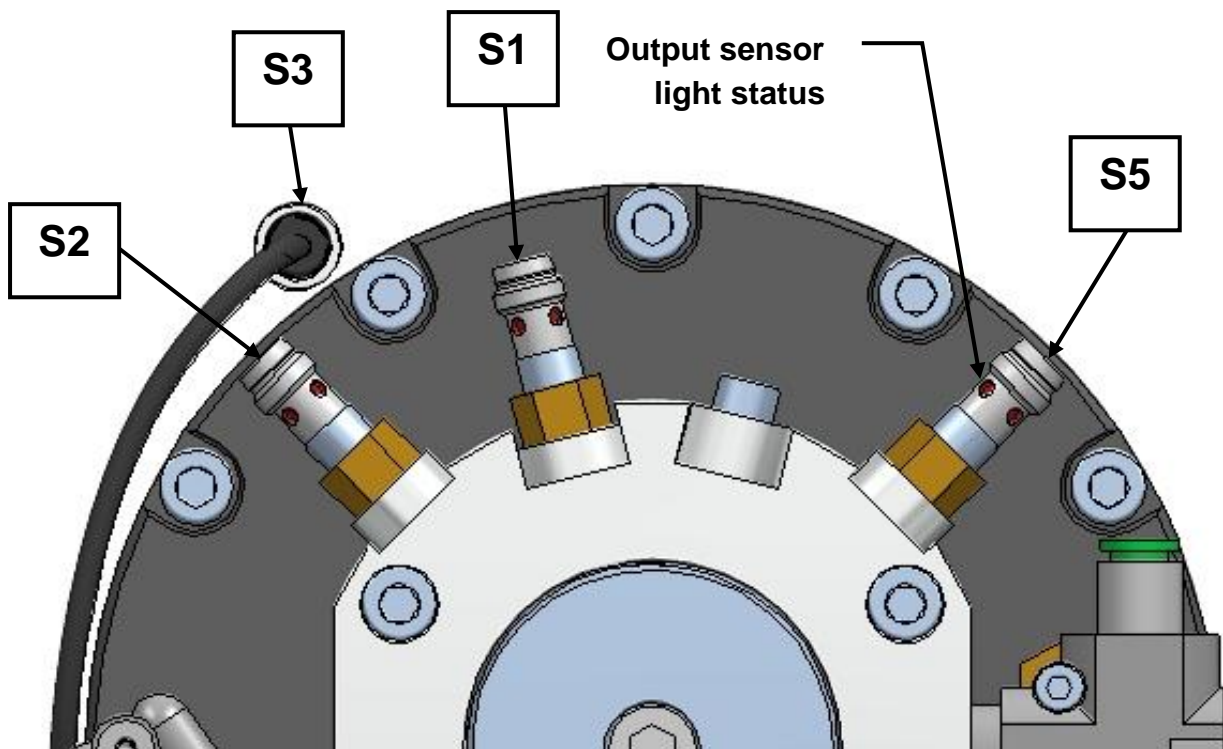

Fig. 5 Sensors layout

### 8.14.1. TECHNICAL CHARACTERISTICS OF THE INDUCTIVE SENSORS

Type proximity PNP normally-open (NO)	
Supply voltage	10-30V DC typically 24V DC
Maximum load	100 mA
Power consumption with no load	<10 mA
Nominal detection distance	0.8mm
Max switching frequency	3000Hz
Degree of protection	IP67

### 8.14.2. STATUS MODES OF THE ELECTROSPINDLE AND CORRESPONDING OUTPUTS

<b>i</b>	<p><i>The “ON” condition corresponds to an output equal to the supply voltage of the sensor;</i></p> <p><i>The “OFF” condition corresponds to an output equal to 0V.</i></p>
----------	--

STATE	S1	S5	S2	ACTION
Collet open	OFF	OFF	ON	The tool-holder is released.
Collet closed but tool-holder absent	OFF	ON	OFF	The tool-holder is not engaged correctly. It is not allowed machining. The electrospindle cannot run.
Tool-holder blocked correctly	ON	ON	OFF	It is allowed machining.

	<p><i>it is possible to run the electrospindle when the sensors S1 and S5 are both turned “ON”; if the sensor S1 or the sensor S5 turns “OFF” stop immediately the electrospindle shaft rotation.</i></p>
--	---

### 8.14.3. TRIMMING SENSORS

The sensors are already trim in the factory, but if it is necessary to trim the sensors see the following instruction:

- Supply the sensor connecting only the circular signal connector.
- Unscrew the M4 screw a little bit.
- Turn the adjusting nut SW9 until the light sensor turns on, continue for 30°.
- Tighten the screw M4 while holding the nut SW9.
- Control the correct functioning of the sensor.

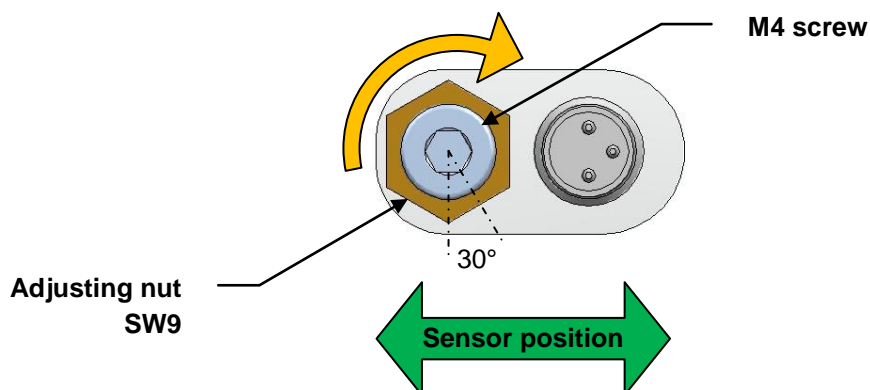
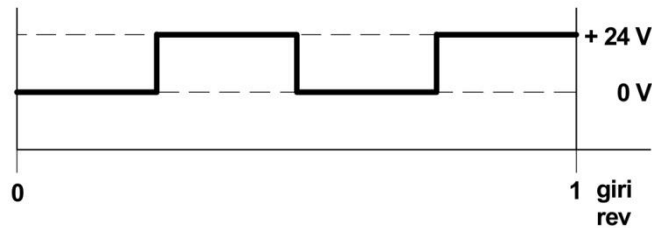

Fig. 6 Trimming sensor system



### 8.14.4. SENSOR S3 OUTPUT

The output of sensor S3 provides information about the speed of the electrospindle. Sensor S3 works by providing two pulse output per revolution of the shaft. See the diagram below.



<b>i</b>	<p><i>The sensor frequency switching is higher than the frequency of shaft at maximum speed; so it is possible to control the electrospindle speed range completely.</i></p> <p><i>it is possible to use a frequency-analogue converter to convert the S3 sensor digital signal to proportional analogue signal.</i></p>
----------	--

### 8.14.5. THERMAL ALARM

Thermal protection is an important protection in electrospindles. Electrospindles can get heated due to overloading, high ambient temperature, variations in power quality, etc. Thermal overload can result in stator overheating, faulty operation and in some extreme cases even fire. Hence, all motors need to be fitted with protection against thermal overload.

The electrospindle is equipped with a bi-metallic normally-closed contact which is mounted in the stator windings. The electrical contact is interrupted when the stator windings reaches thermal alarm temperature. The contacts will automatically reset once the electrospindle cools to a safe predefined level.

The thermal alarm must be connected to the machine control (PLC) which stop the machining operations as quickly as possible and switch off immediately the electrospindle if the thermal alarm contact becomes opens.

Power supply	48V DC MAX
Current	0.6A MAX
Contact breaking time	<1 ms
Contact resistance	<50 mΩ
Insulation voltage	2kV

## 9 MAINTENANCE

Read this section carefully before attempting any maintenance on the electrospindle. This section contains information that is important for the safety of maintenance personnel and for the reliability of maintenance work itself.





All applicable safety precautions must be taken whenever maintenance work is done on the electrospindle. In particular:

- Maintenance and/or lubrication must be performed only by qualified, expert personnel, with the authorization of factory management, in compliance with applicable safety directives and standards, and with the use of suitable tools and instruments.
- When performing maintenance, always wear suitable clothing such as tight fitting work overalls and safety shoes. Never wear long or slack clothing or clothes with parts that hang loose.
- When performing maintenance on a machine, cordon it off and mark it clearly with panels stating "MACHINE UNDERGOING MAINTENANCE".

During all maintenance work make sure that the electrospindle is:

- disconnected and insulated from the electrical power supply;
- fully stopped (not still spinning).

Maintenance managers must ensure that their team is trained to ensure optimum coordination and safety. All persons performing maintenance must remain fully visible to colleagues at all times so that they can signal for assistance if necessary.

	<p><b><i>Use only suitable lifting and moving equipment to disconnect or remove heavy parts from the machine.</i></b></p>
	<p><b><i>Inside the electrospindle there is a pre-loaded spring with a force of several hundred kilograms. The spring is matched to a tie-rod that may fly out violently.</i></b></p> <p><b><i>Carry out the operations described in this manual, paying close attention to the instructions given.</i></b></p>
	<p><b><i>Only the adjustment and replacement operations with original Teknomotor spare parts described in this chapter are permitted.</i></b></p> <p><b><i>Any other type of operation is not permitted and will invalidate the product guarantee.</i></b></p>
	<p><b><i>Special tools are not normally required for electrospindle maintenance.</i></b></p>

## 9.1. SCHEDULED MAINTENANCE AND CLEANING THE SPINDLE SHAFT TOOL HOUSING

Always keep the tool housing in the spindle shaft perfectly clean and free from dust, grease, coolant, oil, metal shavings, and corrosion or lime scale.

Dirty housings cause incorrect tool seating, misalignment with respect to the spindle's axis of rotation, and tool slippage. Dirt can also damage the surface of the housing, causing poor machining precision, and causing risk of injury to operating personnel.

For this reason, check at every tool change for the manual tool changing spindles and at least once a day for the automatic tool changer electrospindle that the surfaces of the spindle shaft, taper, tool housing and tool itself are perfectly clean.

These parts can be cleaned using standard commercial detergents for metal surfaces. When cleaning, take the opportunity to check the condition of the surfaces for wear or damage.

### 9.1.1. CHECK THE CLEANING OF TOOL-HOLDER CONE AND CONICAL HOUSING OF THE ELECTROSPINDLE SHAFT

#### Frequency: DAILY

Before using the electrospindle, ensure that the conical surface of the tool-holders and the conical surface of the electrospindle shaft are thoroughly clean, with no particles of dust, grease, cooling liquid, oil etc.

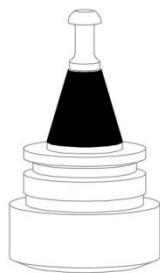

**ISO**

Conical surface of the ISO tool-holder  
(highlighted in black)

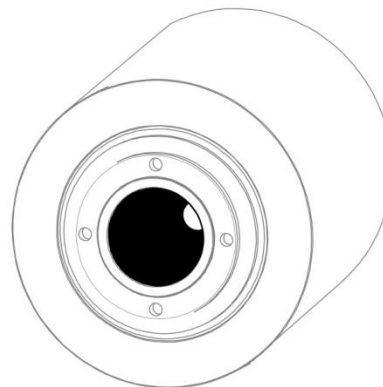

Conical surface of the ISO spindle  
shaft (highlighted in black)





***Do no direct jets of compressed air into the spindle shaft when the tool-holder is absent.***

***Do no direct jets of compressed air on the nose spindle and in particular in seals labyrinth area.***



### 9.1.2. PROTECTING THE CONICAL SEAT IN THE SPINDLE SHAFT

Frequency: **DAILY**

	<i>The seat of the electrospindle shaft cone must always be protected from impurities: use a closing device.</i>
	<i>At the end of the day when the machining operations are finished, always remove the tool-holder from the electrospindle to avoid any problem of sticking between tool-holder and electrospindle shaft. Protect the electrospindle shaft cone from dust.</i>

### 9.1.3. CLEANING THE TOOL-HOLDER CONE

Frequency: **EVERY TWO WEEKS**

Carefully clean the conical surface of the tool-holders with a clean soft cloth and ethyl alcohol.

### 9.1.4. CHECK THE CONNECTIONS

Frequency: **MONTHLY**

Check the integrity of the electrical cables of both power and signal and the fixing of connector. Check the seal of the tubes and connectors of the compressed air circuits.

## 9.2. OCCASIONAL MAINTENANCE

Clean the grill of the cooling fan and remove any objects blocking the airways and control the fixing screws.

	<i>The bearings are lubricated for life and do not require greasing.</i>
---	--

Component parts must be removed and refitted only by qualified personnel authorized by Teknomotor S.r.l.

	<i>Only replacement of parts with original Teknomotor spares and the subsequent adjustment of the newly fitted parts is authorized. No other type of work is authorized and, if it is done, it will lead to the cancellation of the warranty. Please contact Teknomotor S.r.l. if you need more information.</i>
---	--

## 10. TROUBLESHOOTING

PROBLEM	PROBABLE CAUSE	CORRECTIVE ACTION
<b>Excessive vibration during machining</b>	<ul style="list-style-type: none"> <li>• Unbalanced tool.</li> <li>• Incorrectly fitted tool.</li> <li>• Excessive cutting parameters.</li> <li>• Incorrect inverter settings.</li> <li>• Tool too big or too heavy.</li> </ul>	<ul style="list-style-type: none"> <li>• Balance the tool.</li> <li>• Check that the tool is correctly fitted.</li> <li>• Adjust (reduce or increase) the various cutting parameters.</li> <li>• Check the inverter settings.</li> <li>• Try machining with smaller tools.</li> </ul>
<b>Bearings noise</b>	<ul style="list-style-type: none"> <li>• Damaged bearings.</li> </ul>	<ul style="list-style-type: none"> <li>• Send the electrospindle to Teknomotor S.r.l.</li> </ul>
<b>The electrospindle get very hot and is stopped by the PTC thermistor signal</b>	<ul style="list-style-type: none"> <li>• Incorrect inverter settings.</li> <li>• Power settings too high.</li> <li>• Machining speeds too low for the power requirement.</li> <li>• Cooling fan grill blocked.</li> <li>• Cooling fan broken.</li> </ul>	<ul style="list-style-type: none"> <li>• Set the inverter parameters according to the plated values.</li> <li>• Contact the Teknomotor Technical Office.</li> <li>• Check the cooling fan grill and remove any blockage.</li> <li>• Replace the broken fan.</li> </ul>

## 11. DISPOSING OF THE ELECTROSPINDLE

At the end of the electrospindle working life it is the customer's responsibility to dispose of it correctly. First of all, clean the unit and separate the various components into mechanical and electrical parts. Then separate the component parts according to type of material: electric motors (copper windings), metal parts (body, etc.), plastic parts, etc.. Dispose of the various materials in compliance with the laws and regulations applicable in the country where the electrospindle has been installed.

## 12. USEFULL ADRESSES

Headquarters: Teknomotor S.r.l.  
Via Argenega, 31  
32038 Quero Vas (BL)  
Italy

Tel. 0039 0439 787950  
Fax 0039 0439 780147

Website: [www.teknomotor.com](http://www.teknomotor.com)  
Sales: [info@teknomotor.com](mailto:info@teknomotor.com)  
Technical Office: [tecnico@teknomotor.com](mailto:tecnico@teknomotor.com)  
Administration: [amministrazione@teknomotor.com](mailto:amministrazione@teknomotor.com)  
Purchase department: [acquisti@teknomotor.com](mailto:acquisti@teknomotor.com)

**APPENDIX: ATC71 DRAWINGS AND POWER-TORQUE CURVES**

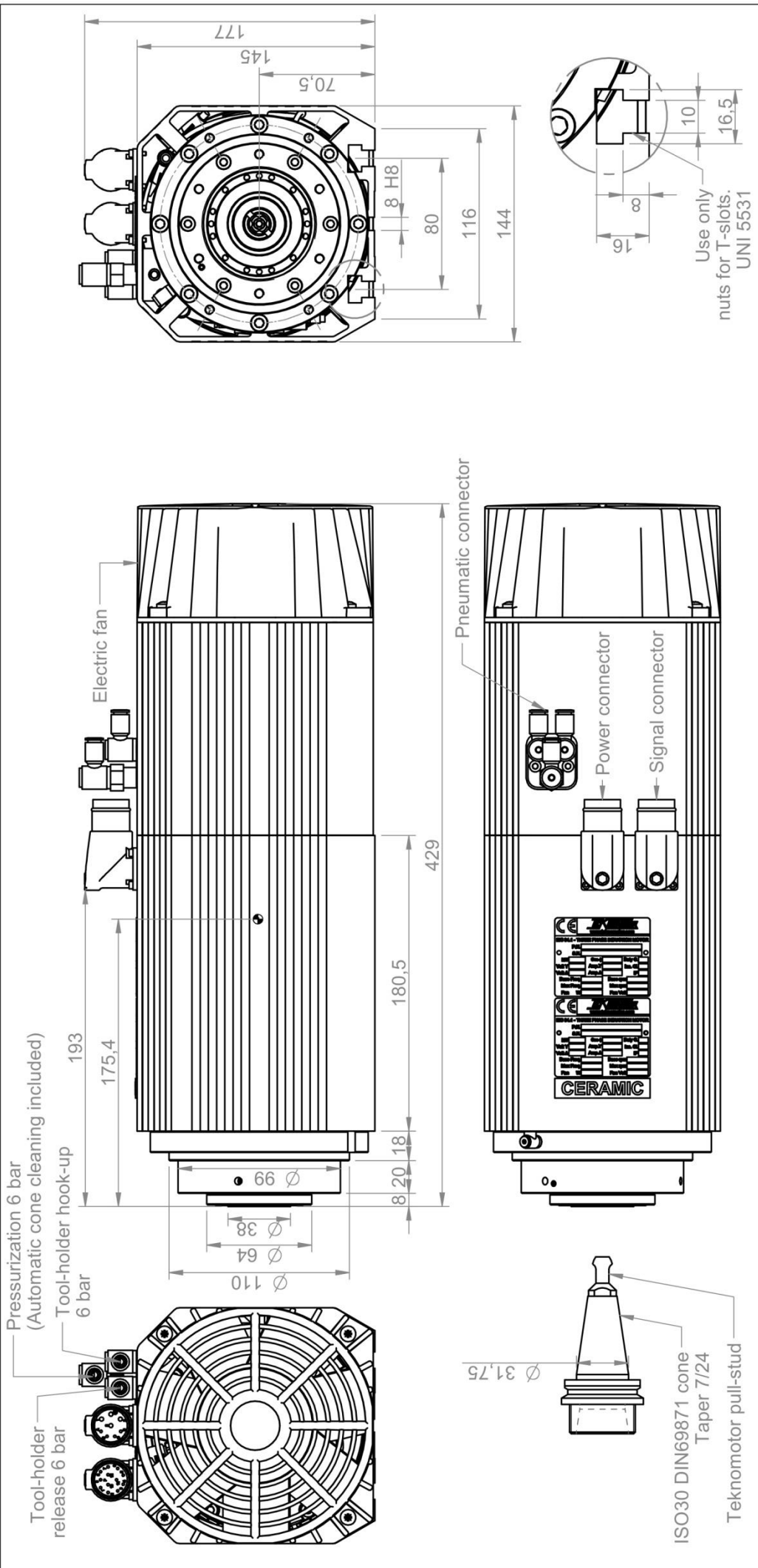

<b>TEKNO MOTOR</b>		Teknomotor S.r.l. Via Argenega 31, I-32038 Quero Vas (BL) www.teknomotor.com	
Title <b>ATC71-A-ISO30-SN</b>		Customer <b>Catalogo</b>	
Base frequency [Hz] <b>200</b>		Signature Ing. Bottarel	
Base voltage [V] <b>380</b>		date 05/08/2014	
Customer part number <b>TC710001</b>		sostituisce il sostituito dal	
Absorb. [A] <b>8.3/10</b>		date 05/09/2014	
tool type Full key		approved Ing. Perli	
tool type Half key		date 05/09/2014	
peso / weight <b>20.28 kg</b>		sostituisce il sostituito dal	
Balancing type <b>-</b>		date 05/09/2014	
Power [kW] <b>3.8/4.6</b>		approved Ing. Perli	
Base speed [rpm] <b>12000</b>		date 05/09/2014	
Max speed [rpm] <b>24000</b>		sostituisce il sostituito dal	
Balancing type <b>-</b>		date 05/09/2014	
Min speed [rpm] <b>3000</b>		approved Ing. Perli	
Absorb. [A] <b>8.3/10</b>		date 05/09/2014	
Balancing type <b>-</b>		sostituisce il sostituito dal	
Tolleranze non quotate: $\pm 0.5\text{mm}$ Smussi non quotati: $\pm 0.5\text{mm}$		date 05/09/2014	
rev. n° <b>00</b>		description <b>Emissione</b>	
drawn Ing. Bottarel		approved Ing. Perli	
Title <b>ATC71-A-ISO30-SN</b>		Customer <b>Catalogo</b>	
Code <b>COMTC710001</b>		drawing n° <b>2673</b>	
foglio / sheet <b>1 / 2</b>		scala <b>1:2</b>	
A4		A4	

1	Power connector	U
2		V
3		W
4		Ground
5		Fan (L) 220V
6		Thermal protection
7		Thermal protection

1	Signal connector	S1
2		S2
3		S3 tacho
4		not used
5		S5
6		0 V
7		+24V DC

Il presente disegno è di proprietà esclusiva di Teknomotor S.r.l. La riproduzione totale o parziale e la divulgazione a terzi, senza nostro esplicito consenso scritto, verrà perseguito secondo i termini di legge in vigore.

# ATC71-A TORQUE AND POWER CURVES



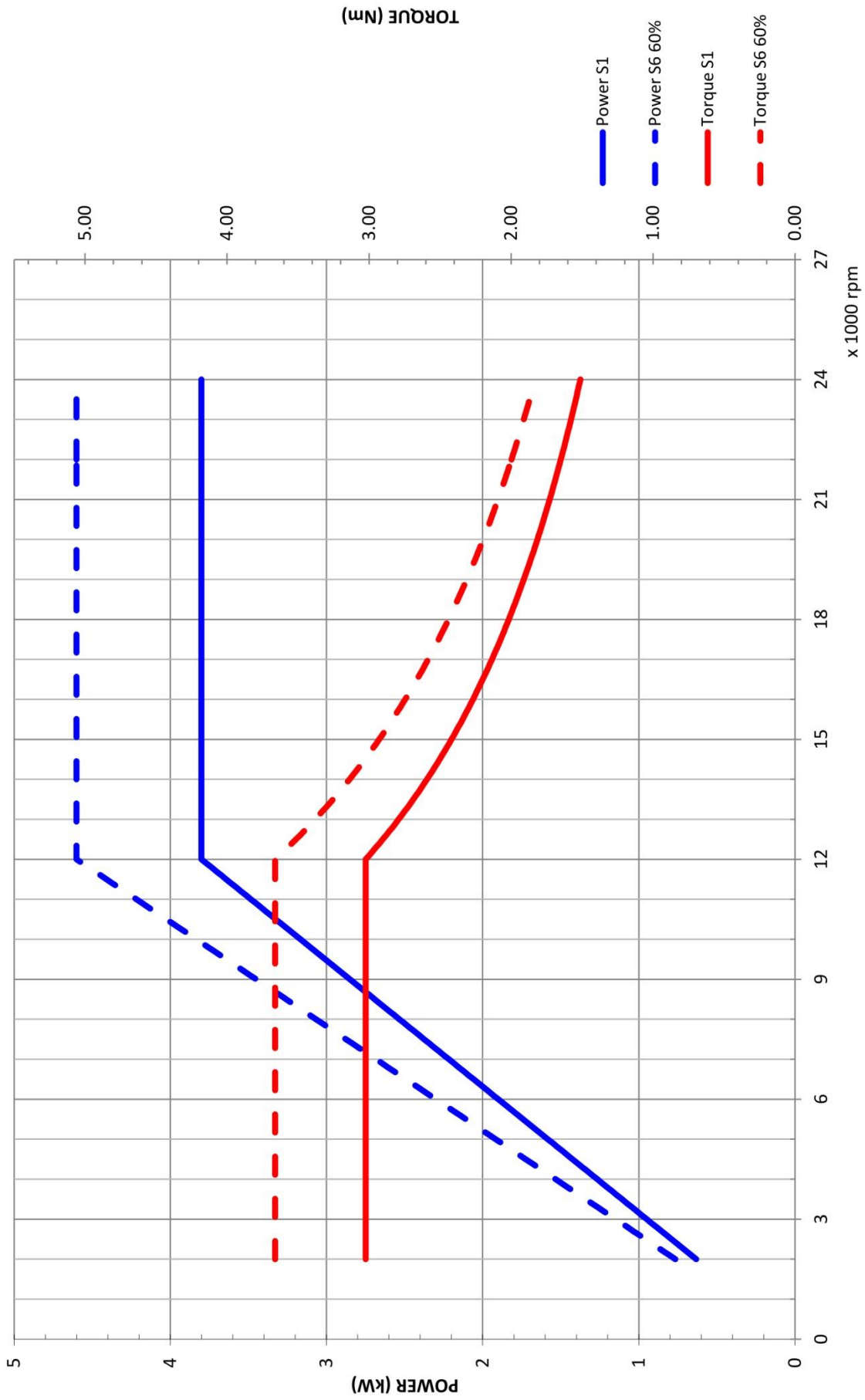

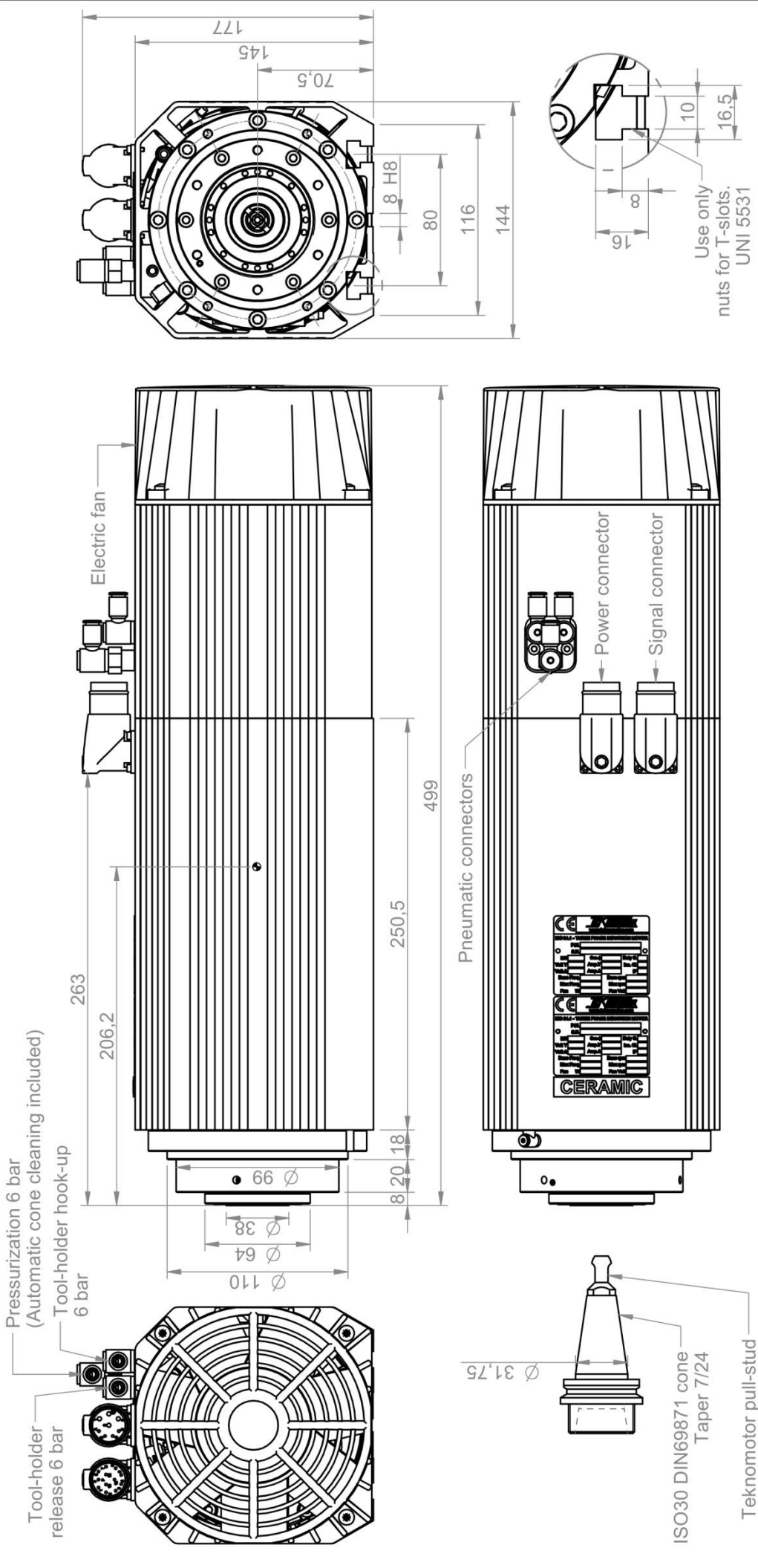

Use only nuts for T-slots. UNI 5531



Teknomotor S.r.l.  
Via Argemega 31, I-32038 Quero Vas (BL)  
www.teknomotor.com

Title <b>ATC71-B-ISO30-SN</b>	
Customer <b>Catalogo</b>	
Code <b>COMTC710004</b>	drawing n° <b>1674</b>
foglio / sheet <b>1 / 1</b>	scala <b>1:2</b>

Power [kW] <b>5.5/6.6</b>	Base speed [rpm] <b>12000</b>	Base voltage [V] <b>380V</b>	Base frequency [Hz] <b>200</b>
Min speed [rpm] <b>3000</b>	Max speed [rpm] <b>24000</b>	Absorb. [A] <b>11.4/13.4</b>	Customer part number <b>TC710004</b>
Balancing: G2.5 - ISO 1940 @ maximum motor speed	Balancing type	Full key Half key	peso / weight <b>24.39 kg</b>
Tolleranze non quotate: ±0.5mm Simussi non quotate: ±0.5mm	0.8V 3.2V 12.5V	~ = V ~ = V	
rev. n° <b>00</b>	description <b>Emissione</b>	date <b>05/08/2014</b>	Signature <b>Ing. Bottarel</b>
drawn <b>Ing. Bottarel</b>	approved <b>Ing. Perli</b>	date <b>05/09/2014</b>	
		sostituisce il sostituito da:	

Signal connector	
1	S1
2	S2
3	S3 tacho
4	not used
5	S5
6	0 V
7	+24V DC

Power connector	
1	U
2	V
3	W
GND	Ground
A	Fan (L) 220V
B	Thermal protection
C	Thermal protection
D	Fan (N) 220V

Il presente disegno è di proprietà esclusiva di Teknomotor S.r.l. La riproduzione totale o parziale e la divulgazione a terzi, senza nostro esplicito consenso scritto, verrà perseguito secondo i termini di legge in vigore.

# ATC71-B TORQUE AND POWER CURVES

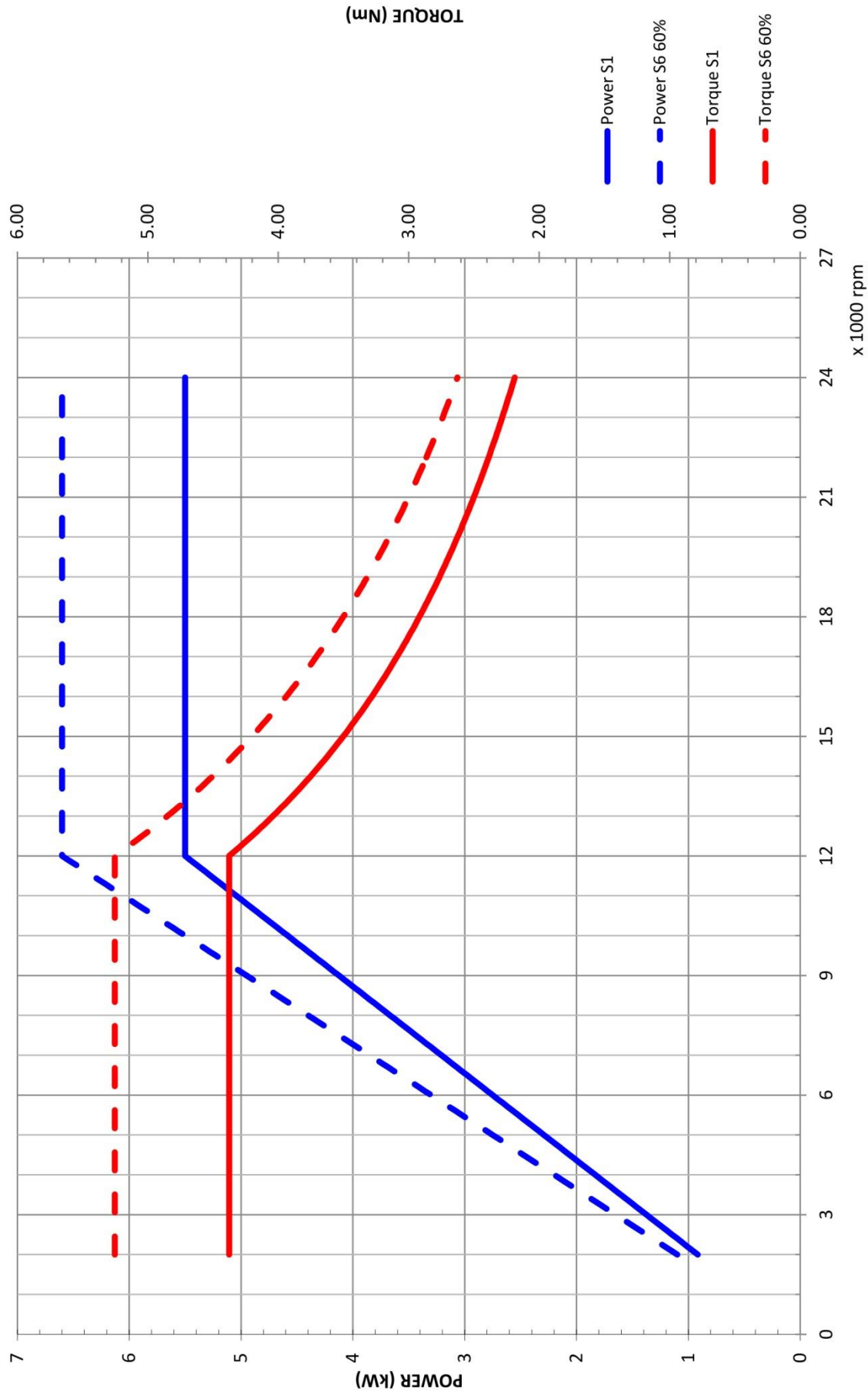

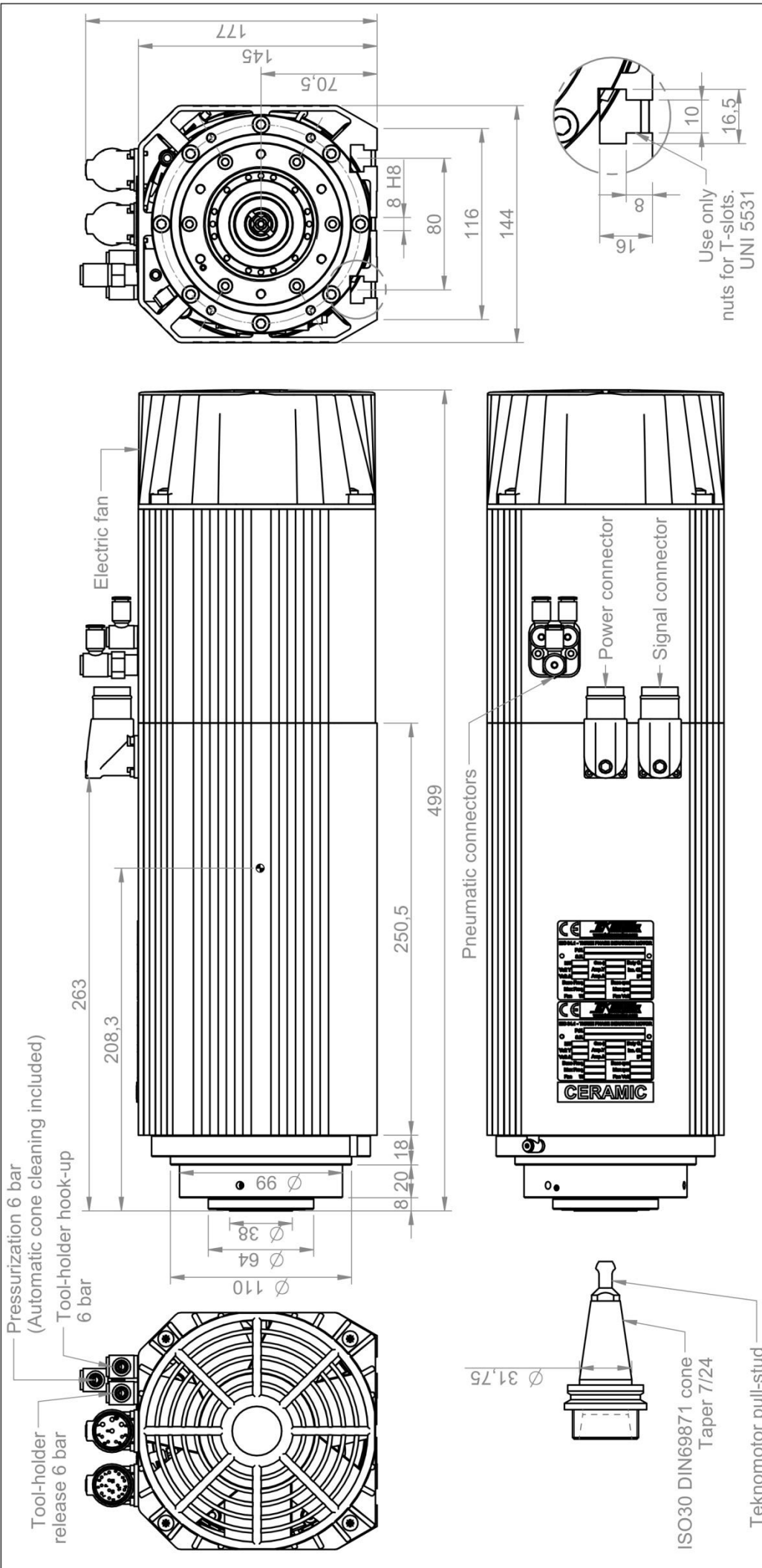

Power [kW]	7.5/9.0	Base voltage [V]	380	Base frequency [Hz]	200
Min speed [rpm]	3000	Absorb. [A]	16.0/19.2	Customer part number	TC710003
Balancing: G2.5 - ISO 1940 @ maximum motor speed		Full key	∅	half key	∅
Tolerances non quotate: ±0.5mm		∅	∅	∅	∅
Smussi non quotate: ±0.5mm		∅	∅	∅	∅
Base speed [rpm]	12000	Max speed [rpm]	24000	Base frequency [Hz]	200
Max speed [rpm]	24000	Balancing type	-	Customer part number	TC710003
Weight	26.43 kg			peso / weight	26.43 kg
rev. n°	00	description	Emissione	date	05/08/2014
drawn	Ing. Bottarel	approved	Ing. Perli	sostituisce il	
		date	05/09/2014	sostituito da	
Code	COMTC710003	Customer	Catalogo	Signature	Ing. Bottarel
drawing n°	2675	Title	ATC71-C-ISO30-SN	Scale	1:1
		folgio / sheet	1/1	Scale	1:2



Teknomotor S.r.l.  
Via Argemega 31, I-32038 Quero Vas (BL)  
www.teknomotor.com

Signal connector	
1	S1
2	S2
3	S3 tacho
4	not used
5	S5
6	0 V
7	+24V DC

Power connector	
1	U
2	V
3	W
GND	Ground
A	Fan (L) 220V
B	Thermal protection
C	Thermal protection
D	Fan (N) 220V

# ATC71-C TORQUE AND POWER CURVES

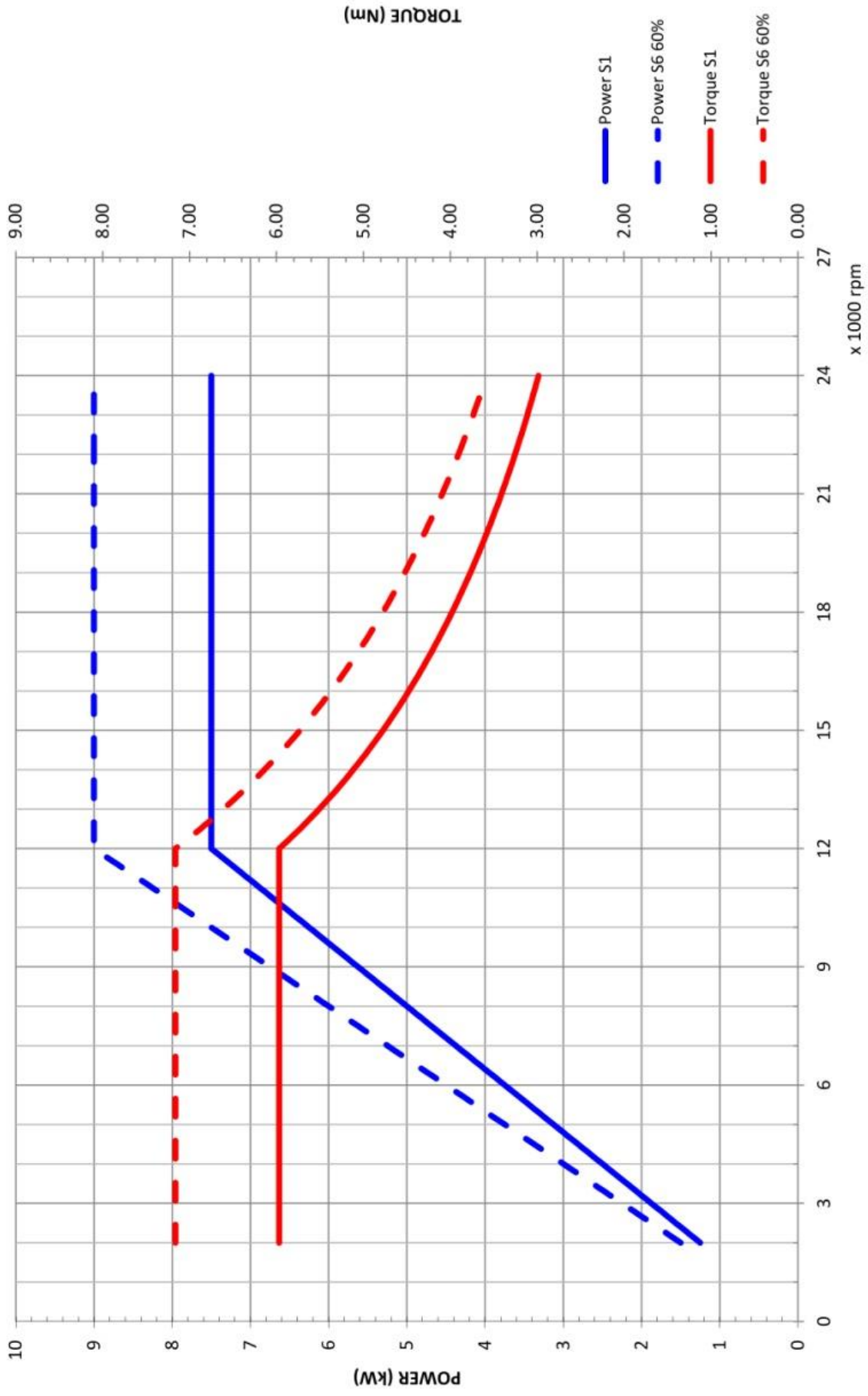

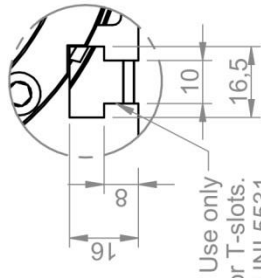
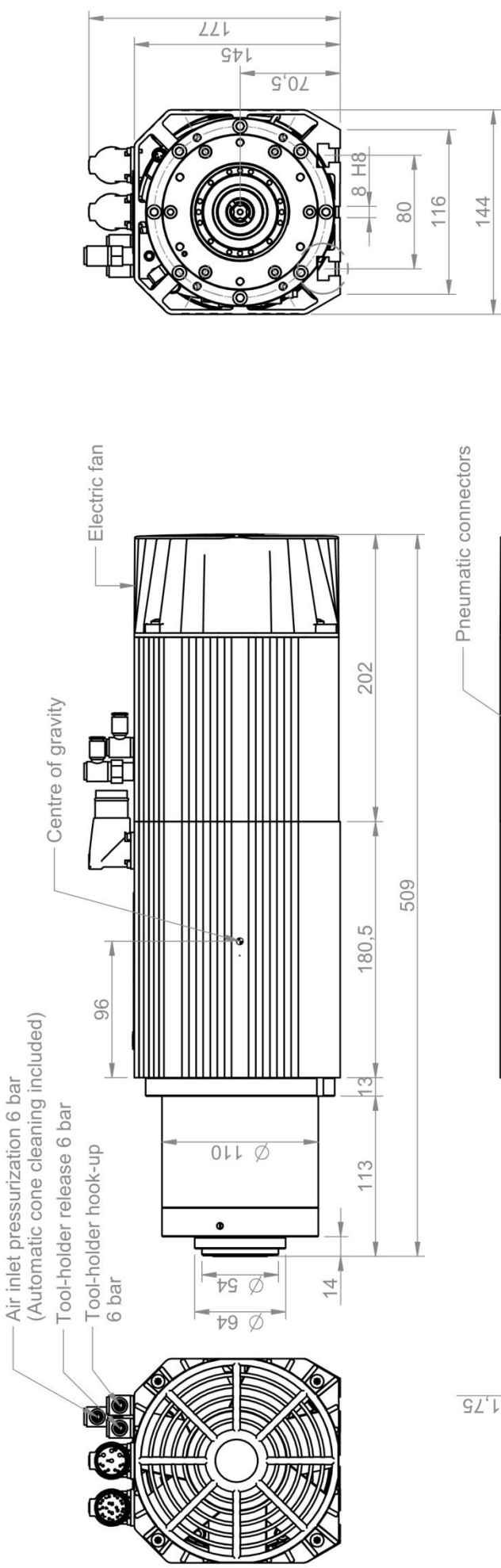

Power [kW] 3.8/4.6		Base speed [rpm] 12000		Base voltage [V] 380		Base frequency [Hz] 200	
Min speed [rpm] 2000		Max speed [rpm] 24000		Absorb. [A] 8.3/10.0		Customer part number TC710007	
Balancing: G2.5 - ISO 1940 @ maximum motor speed		Balancing type -		Tool type Full key		peso / weight 25.93 kg	
Tolleranze non quotate: ±0.5mm Smussi non quotate: ±0.5mm		description 00 Emissione		Tool type Half key		Title ATC71-A-ISO30-LN	
rev. n° 00		date 03/09/2014		date 01/09/2014		Customer Catalogo	
drawn Ing. Bottarelli		approved Ing. Perli		date 03/09/2014		Code COMTC710007	
sostituisce il sostituito dal		date 03/09/2014		date 01/09/2014		drawing n° 3294	
Signal connector		date 03/09/2014		date 01/09/2014		foglio / sheet 1 / 1	
1 S1		approved Ing. Perli		date 03/09/2014		scala 1:2	
2 S2		sostituisce il sostituito dal		date 03/09/2014		A4	
3 S3 tacho		date 03/09/2014		date 01/09/2014			
4 not used		date 03/09/2014		date 01/09/2014			
5 S5		date 03/09/2014		date 01/09/2014			
6 0V		date 03/09/2014		date 01/09/2014			
7 +24V DC		date 03/09/2014		date 01/09/2014			



Teknomotor S.r.l.  
Via Argemone 31, I-32038 Quero Vas (BL)  
www.teknomotor.com

1	S1
2	S2
3	S3 tacho
4	not used
5	S5
6	0V
7	+24V DC

1	Power connector
2	U
3	V
4	W
5	Ground
6	Fan (L) 220V
7	Thermal protection
8	Thermal protection
9	Fan (N) 220V

# ATC71-A TORQUE AND POWER CURVES

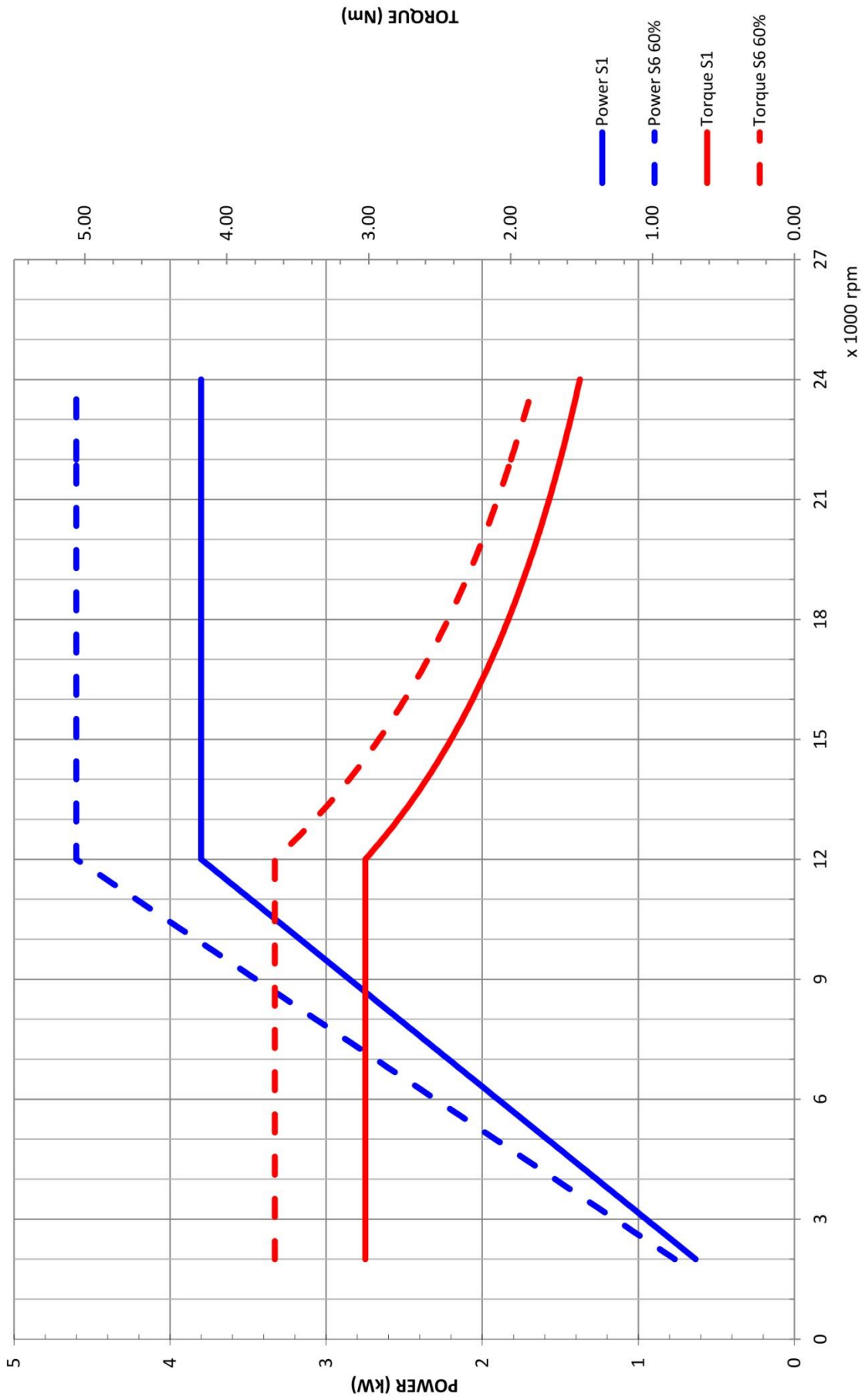

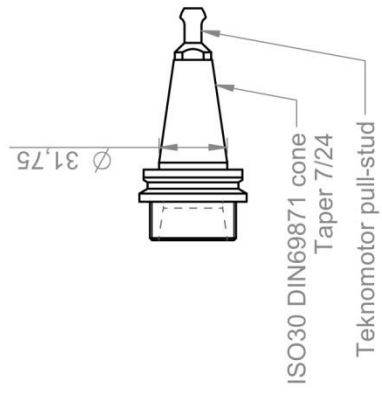
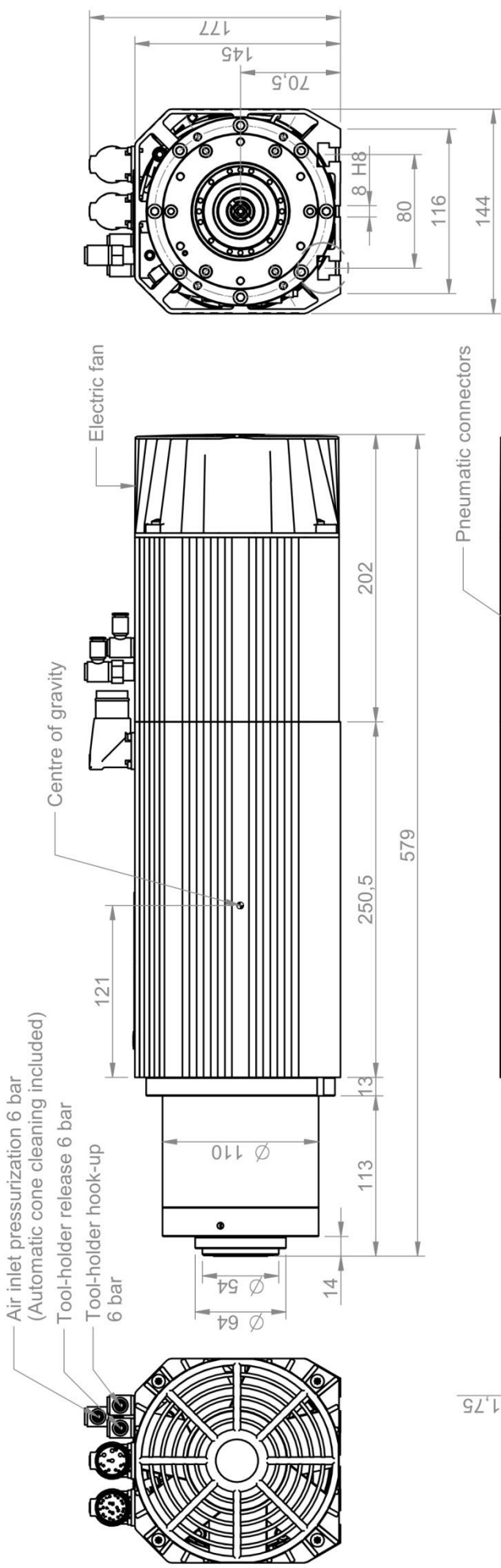

Use only nuts for T-slots. UNI 5531



Teknomotor S.r.l.  
Via Argemegna 31, I-32038 Quero Vas (BL)  
www.teknomotor.com

Power [kW]	5.5/6.6	Base speed [rpm]	12000	Base voltage [V]	380	Base frequency [Hz]	200
Min speed [rpm]	2000	Max speed [rpm]	24000	Absorb. [A]	11.4/13.4	Customer part number	TC710008
Balancing: G2.5 - ISO 1940 @ maximum motor speed		Balancing type	-	tool type	full key	peso / weight	31.76 kg
Tolleranze non quotate: ±0.5mm Smussi non quotate: ±0.5mm				tool type	half key	~ = ∅	
rev. n°	00	description	Emissione	date	01/09/2014	Signature	Ing. Bottarel
drawn	Ing. Bottarel	approved	Ing. Perli	date	05/09/2014	substituisce il	
		date	05/09/2014	sostituito dal		Code	COMTC710008
						drawing n°	3295
						scala	1:2
						folgio / sheet	1 / 1
							A4

Signal connector	
1	S1
2	S2
3	S3 tacho
4	not used
5	S5
6	0 V
7	+24V DC

Power connector	
1	U
2	V
3	W
GND	Ground
A	Fan (L) 220V
B	Thermal protection
C	Thermal protection
D	Fan (N) 220V

Il presente disegno è di proprietà esclusiva di Teknomotor S.r.l. La riproduzione totale o parziale e la divulgazione a terzi, senza nostro esplicito consenso scritto, verrà perseguito secondo i termini di legge in vigore.

# ATC71-B TORQUE AND POWER CURVES

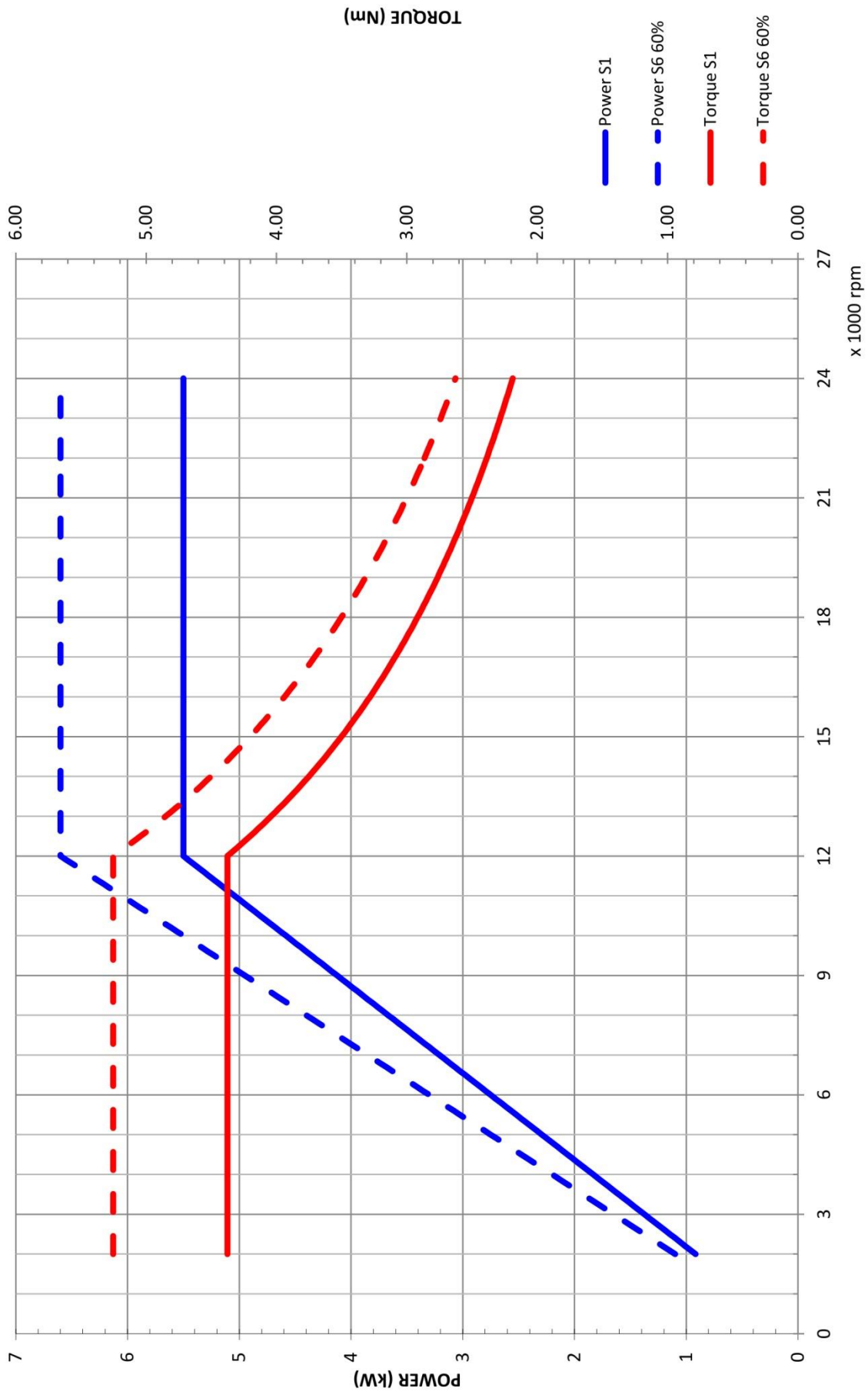



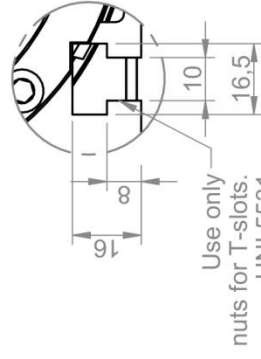
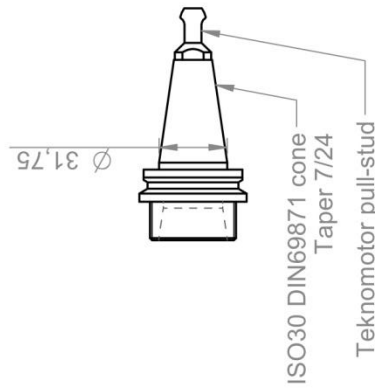
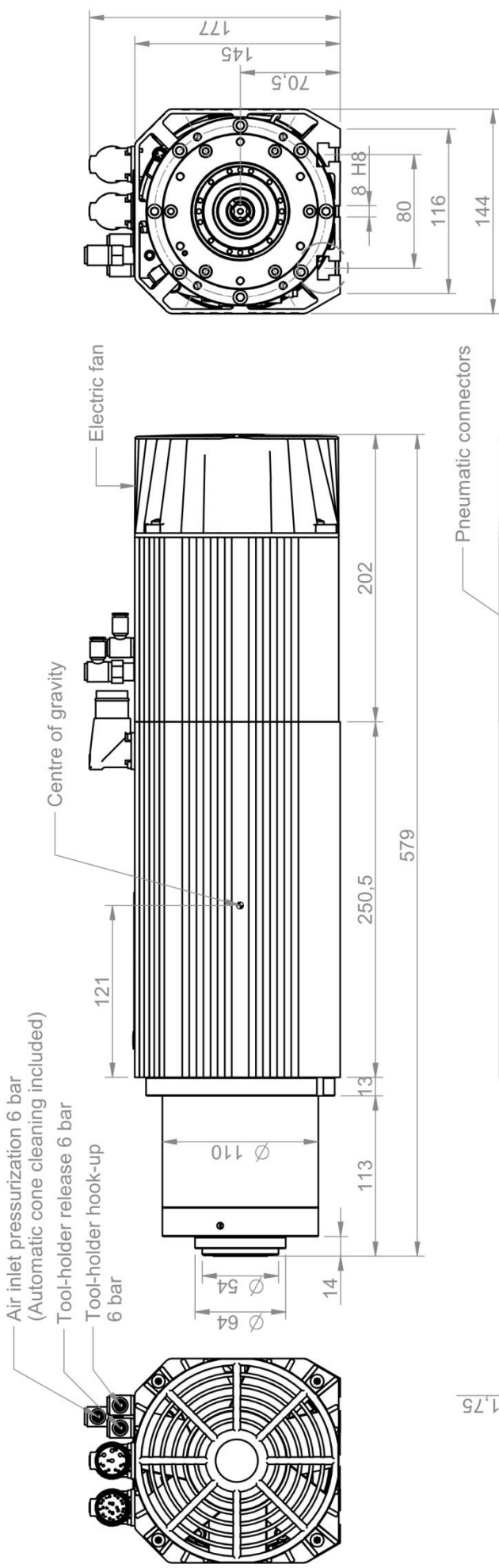

Power [kW]	7.5/9.0	Base speed [rpm]	12000	Base voltage [V]	380	Base frequency [Hz]	200
Min speed [rpm]	2000	Max speed [rpm]	24000	Absorb. [A]	16.0/19.2	Customer part number	TC710009
Balancing: G2.5 - ISO 1940 @ maximum motor speed		Balancing type	-	tool type	full key	peso / weight	31.76 kg
Tolleranze non quotate: ±0.5mm Smussi non quotate: ±0.5mm				tool type	half key		
rev. n°	00	description	00 Emissione	date	01/09/2014	Signature	Ing. Bottarel
drawn	Ing. Bottarel	approved	Ing. Perli	date	03/09/2014	sostituisce il	sostituito dal
Signal connector		1	S1	2	S2	3	S3 tacho
		4	not used	5	S5	6	0 V
		7	+24V DC				
Power connector		1	U	2	V	3	W
			GND		Ground		Fan (L) 220V
			B		Thermal protection		C
			D		Fan (N) 220V		
<p><b>TEKNO MOTOR</b> Teknomotor S.r.l. Via Argemegga 31, I-32038 Quero Vas (BL) www.teknomotor.com</p> <p>Title: ATC71-C-ISO30-LN Customer: Catalogo Code: COMTC710009 drawing n°: 3296 foglio / sheet: 1 / 1 scala: 1:2</p>							

# ATC71-C TORQUE AND POWER CURVES

